



## Installation Guide

For Model:  
**LS52ABZ5CRGD**

### Table of Contents:

Safety Tips. pg. 1  
Unpacking Your Fan. pg. 2  
Parts Inventory. pg. 2  
Installation Preparation. pg. 3  
Hanging Bracket Installation. pg. 3  
Fan Assembly. pgs. 4 - 5  
Wiring. pgs. 5 - 6  
Canopy Assembly. pg. 6  
Blade Assembly. pg. 7  
Light Kit Assembly. pg. 7  
Automated Learning Process./  
Activating Code. pg. 8  
Wall Control Operation. pg. 8  
Remote Control Operation. pg. 9  
Testing Your Fan. pg. 9  
Housing Bulb Replacement. pg. 9  
Troubleshooting. pg. 10  
Warranty. pg. 10  
Parts Replacement. pg. 10



net weight of fan: 30.42 lb. (13.8 kg)

PRINTED IN CHINA

## SAFETY TIPS.

**WARNING:** To reduce the risk of electrical shock, turn off the electricity to the fan at the main fuse box or circuit panel before you begin the fan installation or before servicing the fan or installing accessories.

1. **READ ALL INSTRUCTIONS AND SAFETY INFORMATION CAREFULLY BEFORE INSTALLING YOUR FAN AND SAVE THESE INSTRUCTIONS.**

**CAUTION:** To avoid personal injury, the use of gloves may be necessary while handling fan parts with sharp edges.

2. Make sure all electrical connections comply with Local Codes or Ordinances, the National Electrical Code, and ANSI/NFPA 70-1999. If you are unfamiliar with electrical wiring or if the house/building wires are different colors than those referred to in the instructions, please use a qualified electrician.
3. Make sure you have a location selected for your fan that allows clear space for the blades to rotate, and at least seven (7) feet (2.13 meters) of clearance between the floor and the fan blade tips. The fan should be mounted so that the tips of the blades are at least thirty (30) inches (76 centimeters) from walls or other upright structures.
4. The outlet box and ceiling support joist used must be securely mounted, and capable of supporting at least 35 pounds (16 kilograms). The outlet box must be supported directly by the building structure. Use only UL listed outlet boxes marked "FOR FAN SUPPORT."

**WARNING:** To reduce the risk of fire, electrical shock, or personal injury, mount to the outlet box marked "Acceptable for Fan Support of 15.9 kg (35 lbs.) or less" and use the mounting screws provided with the outlet box. Most outlet boxes commonly used for the support of lighting fixtures are not acceptable for fan support and may need to be replaced. Consult a qualified electrician if in doubt.

**WARNING:** To reduce the risk of fire, electrical shock, or personal injury, wire connectors provided with this fan are designed to accept only one 12 gauge house wire and two lead wires from the fan. If your house wire is larger than 12 gauge or there is more than one house wire to connect to the corresponding fan lead wires, consult an electrician for the proper size wire connectors to use.

5. Electrical diagrams are for reference only. Light kits that are not packed with the fan must be UL listed and marked suitable for use with the model fan you are installing. Switches must be UL general use switches. Refer to the instructions packaged with the light kits and switches for proper assembly.
6. After installation is complete, check that all connections are absolutely secure.
7. After making electrical connections, spliced conductors should be turned upward and pushed carefully up into the outlet box. The wires should be spread apart with the grounded conductor and the equipment-grounding conductor on opposite sides of the outlet box.

**WARNING:** To reduce the risk of electrical shock, fire and to prevent humming noise, do not use this fan with any solid state speed control device or control fan speed with a full range dimmer switch. [Using a full range dimmer switch to control fan speed will cause a loud humming noise from fan.]

8. Do not operate the reverse switch until fan has come to a complete stop.
9. Do not insert anything between the fan blades while they are rotating.

**WARNING:** To reduce the risk of personal injury, do not bend the blade arms during assembly or after installation. Do not insert objects into the path of the blades.

**WARNING:** To avoid personal injury or damage to the fan and other items, be cautious when working around or cleaning the fan.

10. Do not use water or detergents when cleaning the fan or fan blades. A dry dust cloth or lightly dampened cloth will be suitable for most cleaning.

**WARNING:** To reduce the risk of personal injury, use **only** parts provided with this fan. **The use of parts OTHER than those provided with this fan will void the warranty.**

**NOTE:** The important safety precautions and instructions appearing in the manual are not meant to cover all possible conditions and situations that may occur. It must be understood that common sense and caution are necessary factors in the installation and operation of this fan.

# 1. Unpacking Your Fan.

Carefully open the packaging. Remove items from Styrofoam inserts. Remove motor housing and place on carpet or Styrofoam to avoid damage to finish. Do not discard fan carton or Styrofoam inserts should this fan need to be returned for repairs.

Check against parts inventory that all parts have been included.

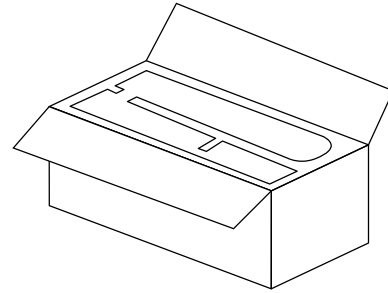

# 2. Parts Inventory.

- a.** hanging bracket. 1 piece
- b.** remote control transmitter. 1 piece
- c.** remote control receiver. 1 piece
- d.** wall control and plate. 2 separate pieces
- e.** yoke cover. 1 piece
- f.** 12in. downrod and hanging ball (with pin and clip). 1 piece
- g.** canopy. 1 piece
- h.** motor housing. 1 piece
- i.** blade arm. 5 pieces
- j.** blade. 5 pieces
- k.** glass shade. 1 piece
- l.** light kit fitter. 1 piece
- m.** finial (pre-attached to light kit fitter). 1 piece
- n.** decorative scroll arms. 1 piece
- o.** safety cable (already attached to motor). 1 piece
- p.** hardware packs

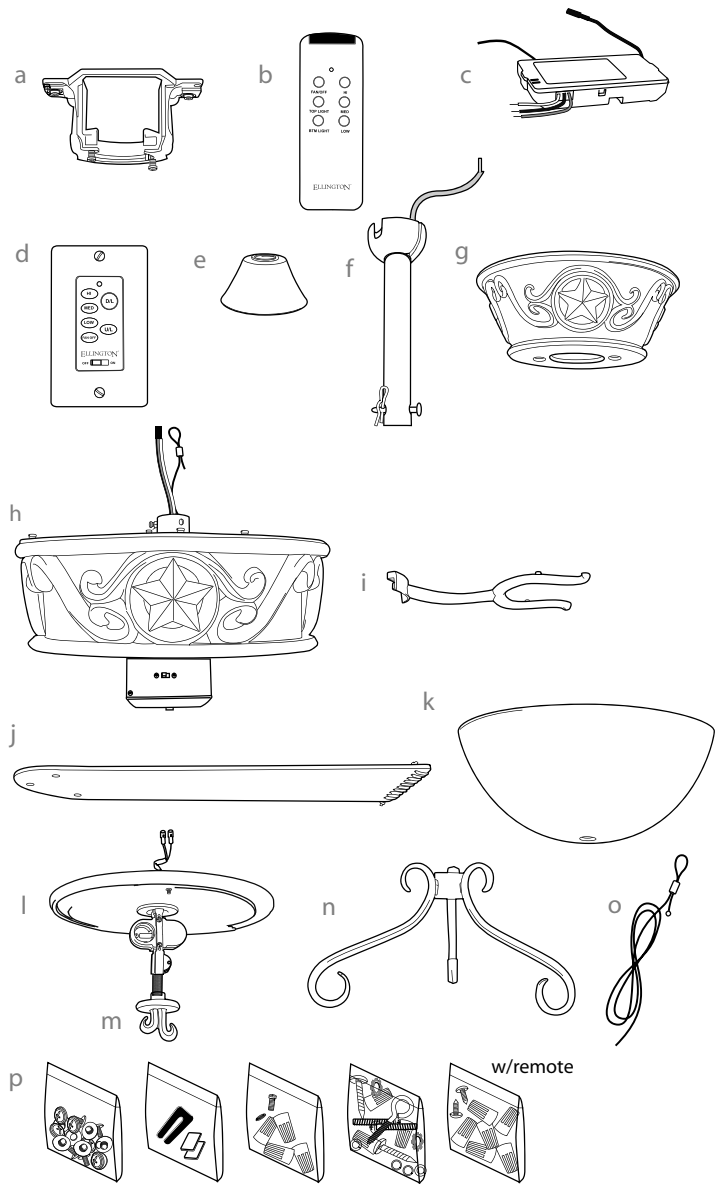

**! IMPORTANT REMINDER:** You must use the parts provided with this fan for proper installation and safety. **!**

**required bulbs:**  
**light kit**--2 x 13 watt medium base compact fluorescent bulbs (included)  
**lighted housing**--3 x 15 watt max. candelabra base bulbs (included)

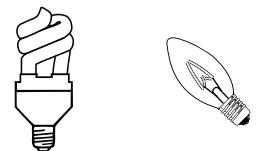

### 3. Installation Preparation.

To prevent personal injury and damage, ensure that the hanging location allows the blades a clearance of 7 feet (2.13m) from the floor and 30in. (76cm) from any wall or obstruction. This fan is suitable for room sizes up to 400 square feet (37.2 square meters).

This fan can be mounted with a **downrod** on a regular (no-slope) or vaulted ceiling. The hanging length can be extended by purchasing a longer downrod (0.5in./1.27cm diameter). Other installation, such as **flushmount**, is *not* available for this fan.

**Installation requires these tools:**

Phillips screwdriver, flathead screwdriver, adjustable pliers or wrench, stepladder, wire cutters, rubber mallet, and rated electrical tape.

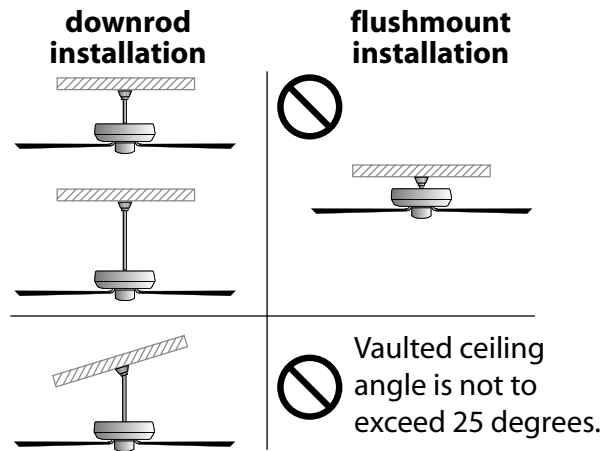
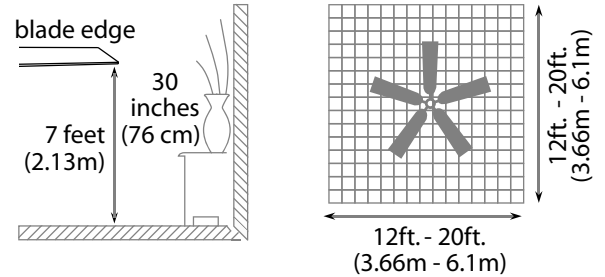

### 4. Hanging Bracket Installation.

Turn off circuit breakers to current fixture from breaker panel and be sure operating light switch is turned to the OFF position.

**WARNING:** Failure to disconnect power supply prior to installation may result in serious injury.

Remove existing fixture.

**WARNING:** When using an existing outlet box be sure the outlet box is securely attached to the building structure and can support the full weight of the fan. Ensure the outlet box is clearly marked "Suitable for Fan Support." If not, it must be replaced with an approved outlet box. Failure to do so can result in serious injury.

**CAUTION:** Be sure outlet box is grounded properly and that a ground wire (**GREEN** or bare) is present.

Install hanging bracket to outlet box using original screws, spring washers and flat washers provided with new or original outlet box.\* If installing on a vaulted ceiling, face opening of hanging bracket towards high point of ceiling. Arrange electrical wiring around the back of the hanging bracket and away from the bracket opening.

**\*Note:** It is very important that you use the proper hardware when installing the hanging bracket as this will support the fan.

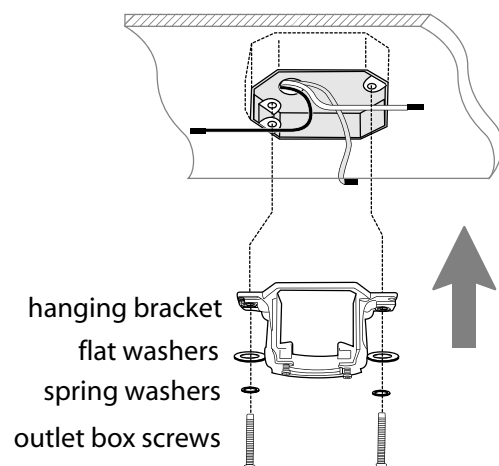
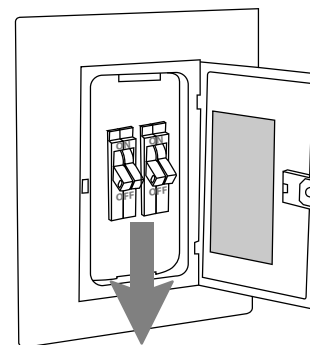

## 5. Fan Assembly.

If you wish to extend the hanging length of your fan, you must remove the hanging ball from the 12in. downrod provided to use with an extended downrod (sold separately). [If you wish to use the 12in. downrod, please proceed to instructions following the dotted line below.]

To remove hanging ball, loosen set screw on hanging ball and remove pin and clip. Lower hanging ball and remove stop pin. Slide hanging ball off the original downrod, A, and slide it down the longer downrod, B (the top of the downrod should be noted as having a set screw hole; use this hole when setting the set screw). Insert stop pin into top of extended downrod and raise hanging ball. Be sure stop pin aligns with slots on the inside of the hanging ball. Tighten set screw securely.

**Tip:** To prepare for threading electrical wires through downrod, apply a small piece of electrical tape to the ends of the electrical wires--this will keep the wires together when threading them through the downrod.

Loosen yoke set screws and nuts at top of motor housing. Remove pin and clip from downrod (if you have not already done so). Slide downrod through canopy, decorative scroll arms and yoke cover.

Thread electrical wires and safety cable through downrod and pull extra wire slack from the upper end of the downrod.

Thread downrod into the motor housing yoke, making sure wires do not get twisted, and then screw downrod all the way into the yoke so that it is secure. Re-insert pin and clip that were previously removed. Tighten yoke set screws and nuts securely. Lower yoke cover to motor housing.

**["Fan Assembly" continued on next page.]**

**NOTE:** The important safety precautions and instructions appearing in the manual are not meant to cover all possible conditions and situations that may occur. It must be understood that common sense and caution are necessary factors in the installation and operation of this fan.

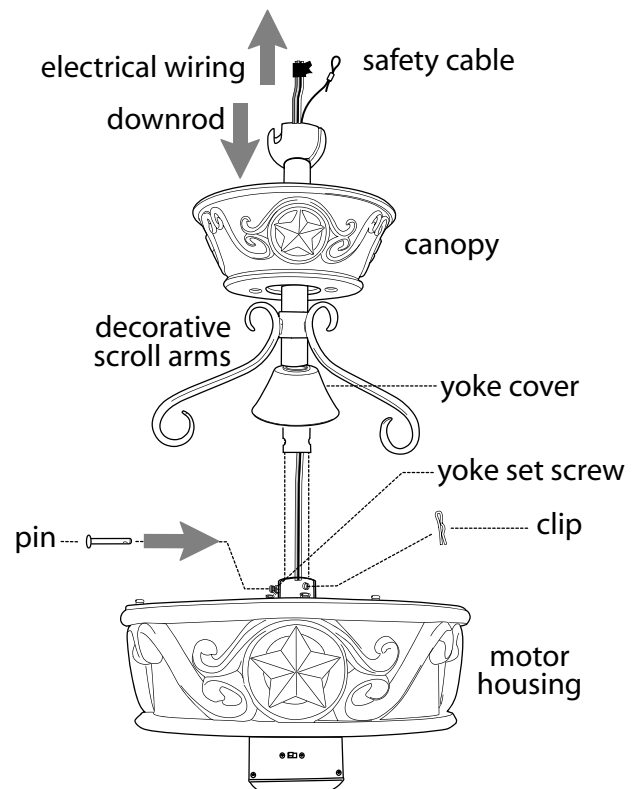
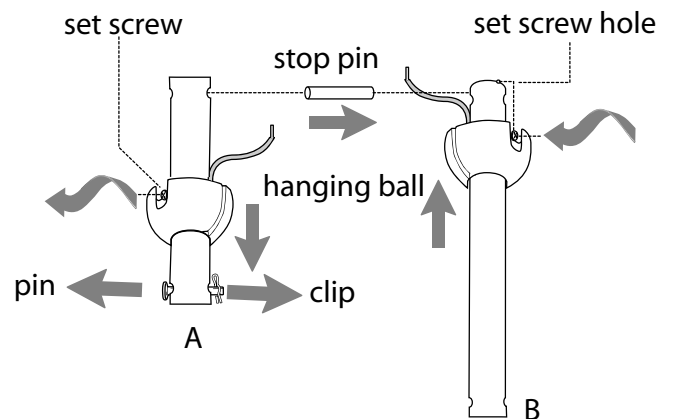

## 5. Fan Assembly. (cont.)

With the hanging bracket secured to the outlet box and able to support the fan, you are now ready to hang your fan. Grab the fan firmly with two hands. Slide downrod through opening in hanging bracket and let hanging ball rest on the hanging bracket. Turn the hanging ball slot until it lines up with the hanging bracket tab.

**Tip:** Seek the help of another person to hold the stepladder in place and to help lift the fan up to you once you are set on the ladder.

Find a secure attachment point (wood ceiling joist highly recommended) and secure safety cable. It will be necessary to use a heavy duty "J" hook with the safety cable loop. The open end of the of the "J" hook should face up toward the roof as shown on the drawing at the right. Make sure that the "J" hook is screwed into the wood ceiling joist completely. If necessary, adjust the loop at the end of the safety cable. The loop at the end of the safety cable should just fit over the threads on the "J" hook. Extra cable slack can be left in ceiling area.

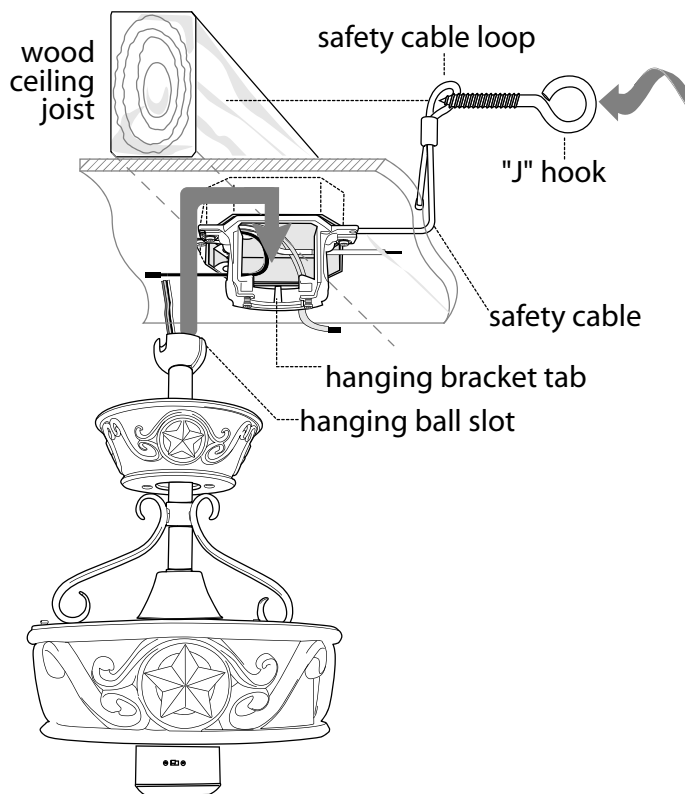

## 6. Wiring.

**CAUTION:** Be sure outlet box is properly grounded and that a ground wire (**GREEN** or Bare) is present.

Make sure all electrical connections comply with Local Codes or Ordinances and the National Electrical Code. If you are unfamiliar with electrical wiring or if the house/building wires are different colors than those referred to in the diagram to the right, please use a qualified electrician.

When downrod is secured in place on the hanging bracket, wire the **RECEIVER** with wire connectors provided as shown in *diagram at right*.

**Tip:** While you are wiring, keep in mind that wires must not obstruct receiver from sliding into hanging bracket.

\* Wrap each wire connector separately with electrical tape as an extra safety measure.

Gently insert receiver (flat side up) into hanging bracket and carefully push wires and taped wire connectors into outlet box. Let antenna rest *outside* of hanging bracket.

**["Wiring" continued on next page.]**

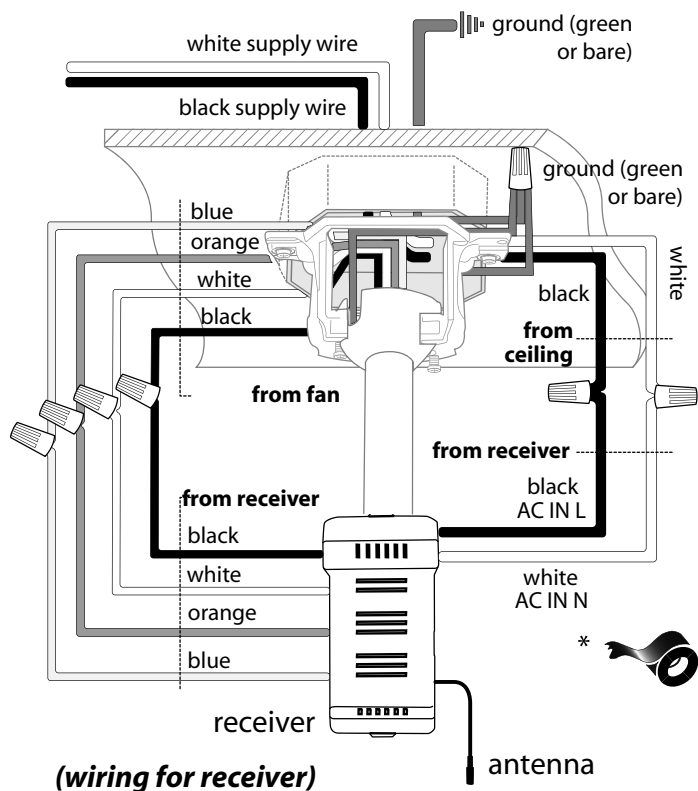

## 6. Wiring. (cont.)

**IN ORDER TO WIRE WALL CONTROL**, remove existing wall switch. Wire the **WALL CONTROL** with wire connectors provided as shown in *diagram at right*.

\* Wrap each wire connector separately with electrical tape as an extra safety measure. Gently push wires and taped wire connectors into outlet box.

Use a ballpoint pen or a small screwdriver to set the code switches 1 through 4 on the wall control. Factory setting is pre-set and not recommended for use. **Write down number sequence for use in Section 10.**

Since this fan comes with compact fluorescent bulbs, the dimmer switch (labeled **D** and **X**) has been pre-set to the "OFF" position (**X**). **Note:** Most compact fluorescent bulbs (including the ones provided with this fan) are not compatible for use with dimmer controls.

Attach wall control to outlet box and secure with screws from original wall switch. Attach front plate to wall control using 2 screws provided with the wall control.

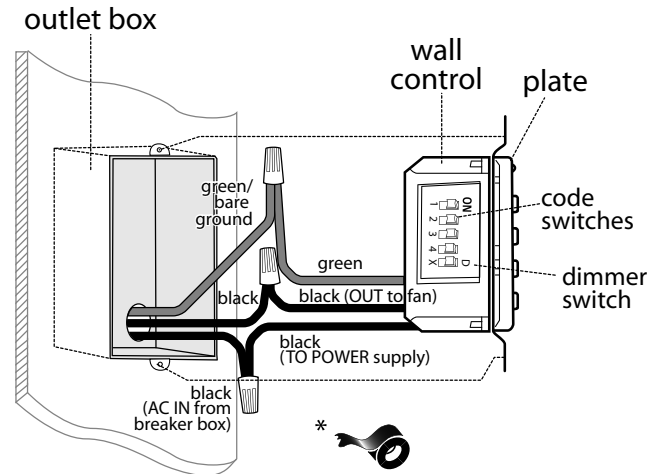

**(wiring for wall control)**

## 7. Canopy Assembly.

Locate 2 screws on underside of hanging bracket and remove screw closest to the open end of the hanging bracket. Partially loosen the other screw. Lift canopy to hanging bracket. Place rounded part of slotted hole in canopy over loosened screw in hanging bracket and push up. Twist canopy to lock. Re-insert screw that was removed, and then tighten both screws securely.

\*Remember that antenna for remote control receiver must rest *outside* of hanging bracket.

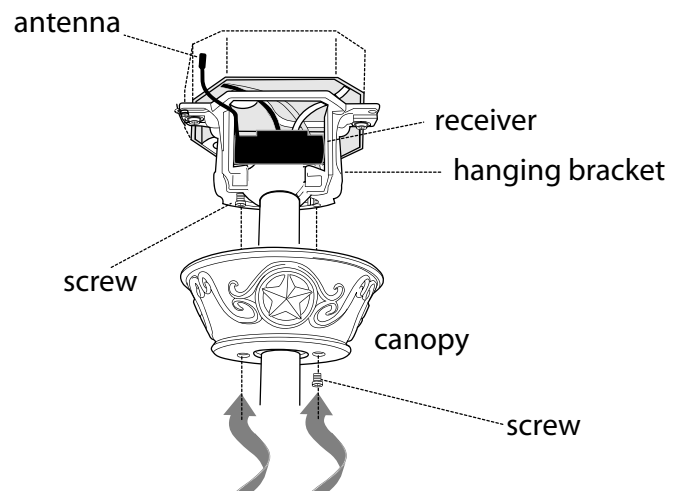

## 8. Blade Assembly.

**Time Saver:** Washers for blade screws can be set on each blade screw prior to installing blades.

Locate 15 blade attachment screws and washers in hardware pack. Hold blade arm up to blade and align holes. Insert 3 blade attachment screws (along with washers) with fingers first and then tighten screws securely with a Phillips screwdriver. Repeat for the remaining blades.

Remove blade arm screws and lock washers from underside of motor. If plastic motor locks are installed with blade arm screws, discard plastic motor locks (*save blade arm screws and lock washers to secure blade arms*). Align blade arm holes with motor screw holes and attach blade arm with lock washers and blade arm screws. Before securing screws permanently, repeat with remaining blade arms. Securely tighten all screws.

**Note:** Tighten blade arm screws twice a year.

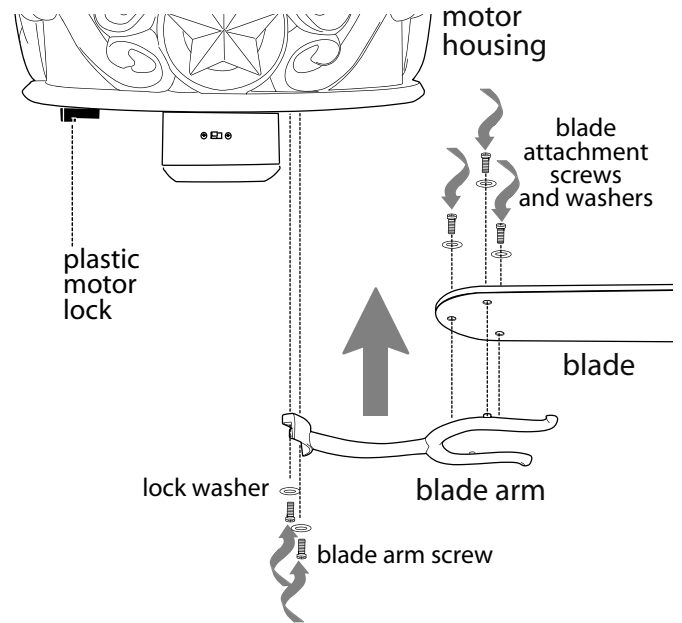

## 9. Light Kit Assembly.

Remove switch housing cap from switch housing by removing 3 screws from switch housing.

Locate **BLUE** (or **BLACK**) and **WHITE** wires in switch housing labeled FOR LIGHT. Remove and discard plastic that hold these 2 wires together.

Remove hex nut and lock washer from threaded rod on light kit fitter. Punch center cap out of switch housing cap with a screwdriver. Gently feed wires from light kit fitter through center hole in switch housing cap. Screw switch housing cap onto threaded rod followed by lock washer and hex nut. Tighten hex nut over lock washer for a secure fit.

Connect **WHITE** wire from light kit fitter to **WHITE** wire from switch housing. Connect **BLACK** wire from light kit fitter to **BLUE** (or **BLACK**) wire from switch housing. Be sure that the mox connections snap together completely. Attach light kit fitter to switch housing with screws that were previously removed. (**Note:** The gap on the top edge of the switch housing cap must align with the reverse switch on the switch housing for the proper fit.) Securely tighten all 3 screws.

Install two 13 watt compact florescent medium base bulbs (included). **Important:** When replacing bulbs, allow glass shade and bulb(s) to cool down before touching.

Remove finial from threaded rod on light kit fitter. Align hole in glass shade with threaded rod and push up gently on glass shade. Secure glass shade to light kit fitter with finial. **Do NOT overtighten finial as glass may crack or break.**

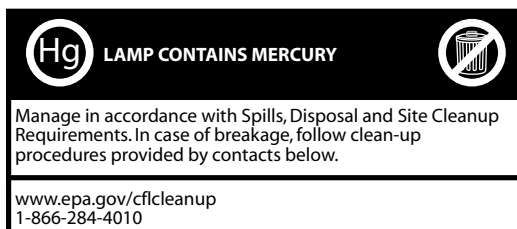
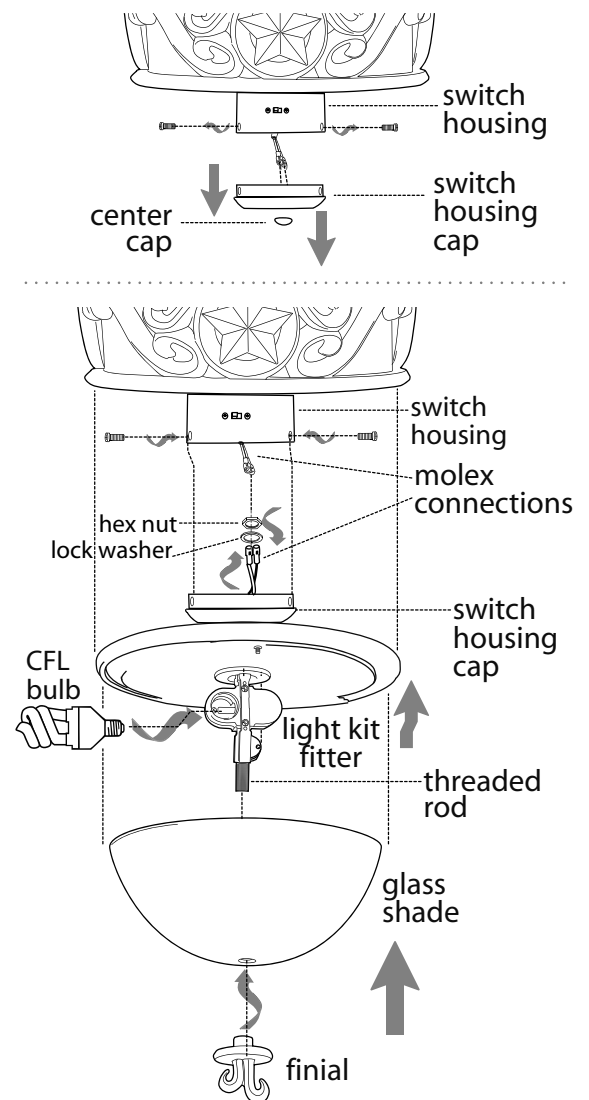



## 10. Automated Learning Process./Activating Code.

**CAUTION:** The remote control transmitter can be programmed to multiple receivers or fans. If this is not desired, turn wall switch off to any other programmable receiver or fan.

This remote control transmitter is equipped with 16 code combinations to prevent possible interference from or to other remote units such as garage door openers, car alarms or security systems. If you find that your fan and light go on and off without using your remote control, simply change the combination code in your remote control transmitter (and wall control). **To set the code, perform these steps:**

Remove battery cover from back side of transmitter.

Use a ballpoint pen or a small screwdriver to set the code switches 1 through 4 for the transmitter. **Use the same number sequence used when wiring the wall control in page 6, Section 6.**

Locate dimmer switch (labeled **D** and **X**) to the right of the code switches. Dimmer switch has been pre-set to the "OFF" position (**X**). [Note: Most compact fluorescent bulbs, including the ones provided with this fan, are not compatible for use with dimmer controls.]

Install 9-volt battery (sold separately) in transmitter and then re-attach the battery cover.

**IMPORTANT:** Store the transmitter away from excess heat or humidity. To prevent damage to transmitter, remove the battery if not used for long periods.

Restore electrical power and then set slider switch on wall control to the ON position. Within 30 seconds of turning on the wall control, press and hold the FAN/OFF button on the front of the transmitter for 5 seconds or until lower light blinks twice. Test the fan and light functions to confirm the learning process is complete--see Section 13.

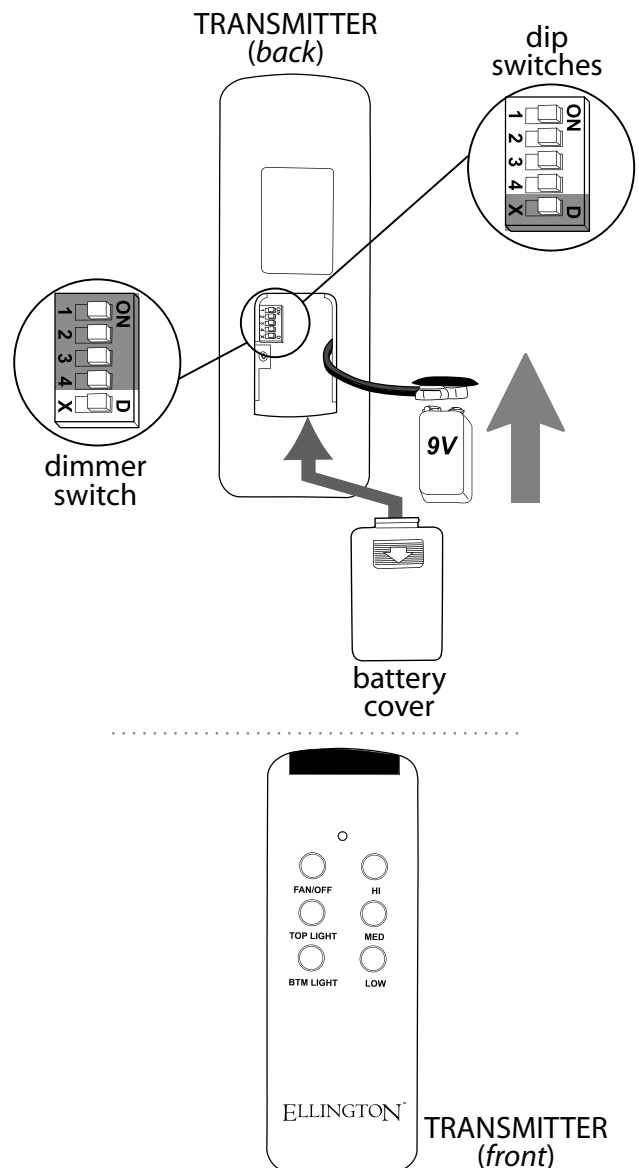

## 11. Wall Control Operation.

**ON/OFF slider switch** - turns *wall control* ON or OFF

**HI** button - turns *fan* to HIGH speed

**MED** button - turns *fan* to MEDIUM speed

**LOW** button - turns *fan* to LOW speed

**FAN OFF** button - turns *fan* OFF

**D/L** button - turns *lower light* ON/OFF when pressed once

**U/L** button - turns *upper light* ON/OFF when pressed once; dims *upper light* when pressed and held down

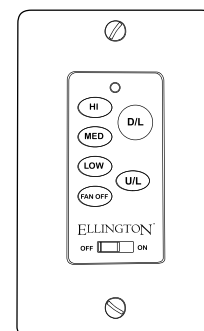

## 12. Remote Control Operation.

**HI** button - turns fan to HIGH speed

**MED** button - turns fan to MEDIUM speed

**LOW** button - turns fan to LOW speed

**FAN/OFF** button - turns fan ON or OFF

**TOP LIGHT** button - push to activate motor housing light ON or OFF

**BTM LIGHT** button - push to activate light kit ON or OFF

Tapping either light button quickly turns top/bottom light ON/OFF. Pressing TOP LIGHT light button and holding it down for more than 0.7 seconds converts it into a dimmer. Auto resume capability keeps top light at same brightness level as the last time it was turned off.

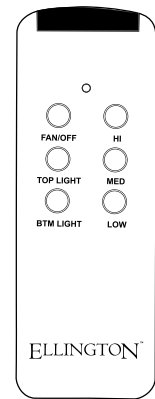

## 13. Testing Your Fan.

It is recommended that you test fan before finalizing installation. Restore power from circuit box and light switch (if applicable). Locate ON/OFF slider switch on wall control and set to the ON position. Test fan lights and then test speeds. Next, locate remote control. Start with the lights OFF and test the light ON/OFF function by pressing the TOP LIGHT, and then the BTM LIGHT button. Test the dimmer function by pressing TOP LIGHT and holding it down for more than 2 seconds. Test fan speeds with the different fan speed buttons. (**diagram 1**) If the remote operates all of the functions of the fan and light, battery has been installed correctly. If the wall and/or remote control do/does not operate all of the fan and/or light functions, refer to "Troubleshooting" section to solve any issues before contacting Customer Service.

Turn fan completely off *before* moving the reverse switch (located on the switch housing). Set reverse switch to recirculate air depending on the season:

- LEFT position in summer (**diagram 2**)
- RIGHT position in winter (**diagram 3**)

A ceiling fan will allow you to raise your thermostat setting in summer and lower your thermostat setting in winter without feeling a difference in your comfort.

**Important:** Reverse switch must be set either *completely to the LEFT* or *completely to the RIGHT* for fan to function. If the reverse switch is set in the *middle* position (**diagram 4**), fan will not operate.

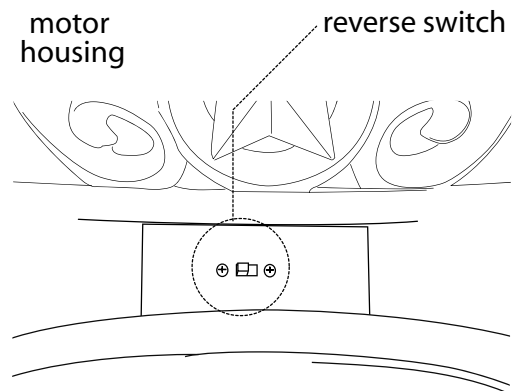

**diagram 1**

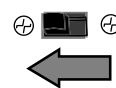

**diagram 2**

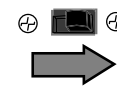

**diagram 3**

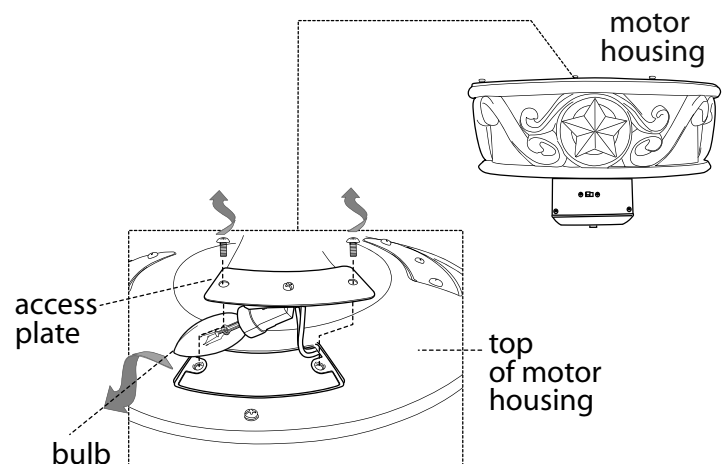

**diagram 4**

## 14. Housing Bulb Replacement.

**Important:** Allow glass housing and light bulbs to cool before touching.

When bulbs in lighted housing need replacement, bulbs may be accessed from access plates on top of motor housing. Use a Phillips screwdriver to remove the 2 screws at either end of the access plate containing burnt-out bulb and lift the end with only *one* screw hole in it. Remove the burned-out bulb and replace bulb with a candelabra base 15 watt max. bulb (sold separately). Re-attach access plate with screws that were removed. Repeat for each burnt-out bulb.



## Troubleshooting.

**WARNING:** Failure to disconnect power supply prior to troubleshooting any wiring issues may result in serious injury.

**Problem:** Fan fails to operate.

**Solutions:**

1. Check power to wall switch/wall control.
2. Check to be sure code switches in remote control transmitter and wall control are set properly.
3. Verify that receiver is wired properly.
4. Verify that fan is wired properly.
5. Verify that wall control is wired properly.
6. Check that red light on remote control transmitter turns on when a button is pressed indicating that the battery is good.
7. Learning process between fan, remote control transmitter may not have been successful and code was not activated. Turn off power and repeat instructions in the last paragraph of Section 10 (page 8).

**Problem:** Light kit not lighting.

**Solutions:**

1. Check power to wall switch/wall control.
2. Check that bulbs are installed correctly.
3. Check to be sure code switches in remote control transmitter and wall control are set properly.
4. Check to be sure wires in canopy are wired properly.
5. Verify that molex plugs in switch housing are connected properly.

**Problem:** Fan operates but light fails.

**Solutions:**

1. Check that bulbs are installed correctly.
2. Replace defective bulbs with same type of bulb.
3. Check to be sure wires in canopy are wired properly.
4. Verify that molex plugs in switch housing are connected properly.

**Problem:** Fan and light fail to operate with remote control.

**Solutions:**

1. Check battery power to remote control.
2. Check to be sure code switches in remote control transmitter and wall control are set properly.

**Problem:** Fan wobbles.

**Solutions:**

1. Use the balancing kit located in one the hardware packs. *If no blade balancing kit is provided, please call Customer Support, 1-800-486-4892, to request one.*
2. Check to be sure set screw(s) on motor housing yoke is (are) tightened securely.
3. Check to be sure set screw on hanging ball is tightened securely.

## Warranty.

CRAFTMADE/ELLINGTON LIFETIME WARRANTY:

CRAFTMADE/ELLINGTON warrants this fan to the original household purchaser for indoor use under the following provisions:

**1-YEAR WARRANTY:** CRAFTMADE/ELLINGTON will replace or repair any fan which has faulty performance due to a defect in material or workmanship. Contact Craftmade/Ellington Customer Service at **1-800-486-4892** to arrange for return of fan. Return fan, shipping prepaid, to Craftmade/Ellington. We will repair or ship you a replacement fan, and we will pay the return shipping cost.

**5-YEAR WARRANTY:** CRAFTMADE/ELLINGTON will repair or replace, at no charge to the original purchaser, any fan motor that fails to operate satisfactorily when failure results from normal use.

**RETURN FAN MOTOR ONLY,** shipping prepaid, to Craftmade/Ellington. We will repair or ship purchaser a replacement motor and Craftmade/Ellington will pay the return shipping cost.

**6-YEAR to LIFETIME LIMITED WARRANTY:**

CRAFTMADE/ELLINGTON will repair the fan, at no charge for labor only to the original purchaser, if the fan motor fails to operate satisfactorily when failure results from normal use. Parts used in the repair will be billed to the purchaser at prevailing prices at time of repair.

The purchaser shall be responsible for all costs incurred in the removal, reinstallation and shipping of the product for repairs.

This warranty does not apply when damage from mechanical, physical, electrical or water abuse results in causing the malfunction. Deterioration of finishes or other parts due to time or exposure to salt air is specifically exempted under this warranty.

Neither Craftmade/Ellington nor the manufacturer will assume any liability resulting from improper installation or use of this product. In no case shall the company be liable for any consequential damages for breach of this, or any other warranty expressed or implied whatsoever. This limitation as to consequential damages shall not apply in states where prohibited.

## Parts Replacement.

For parts and information, please refer to "Parts Inventory" on page 2.

Ellington Customer Support:

**1-800-486-4892**

[www.ellingtonfans.com](http://www.ellingtonfans.com)

**ELLINGTON**  
CEILING FANS **by Craftmade**