

SPECIFICATIONS

**VITA BELLA
PULLS**

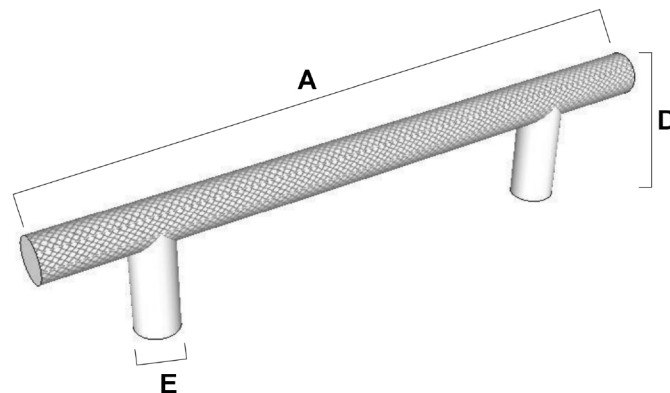
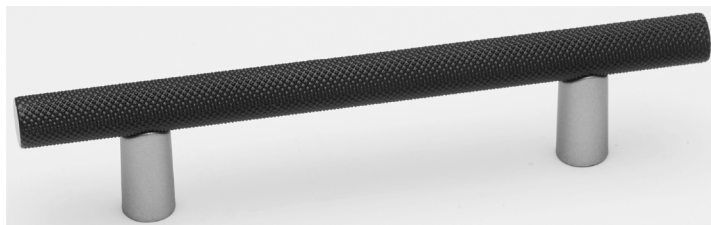

FEATURES

Transitional styling
Multiple finishes
Concealed installation

WARRANTY

Limited lifetime

FINISHES

Matte Black (MB)
Champagne (CHP)
Matte Nickel (MN)
Champagne/Matte Black (CHP/MB)
Matte Nickel/Matte Black (MN/MB)

MATERIAL

Aluminum

Item#	A	B	C	D	E (L)	F (W)
A2902-4	5 31/32"	4"	3/8"	1 1/4"	3/8"	3/8"

KEY:

A - Overall Length
B - Center to Center
C - Width
D - Projection
E - Mount Length
F - Mount Width

NOTE: Dimensions and specifications are subject to change without notice.