

580, 581 & 582 Cabinet Knobs Series

Finishes for Life
TARNISH-FREE GUARANTEED

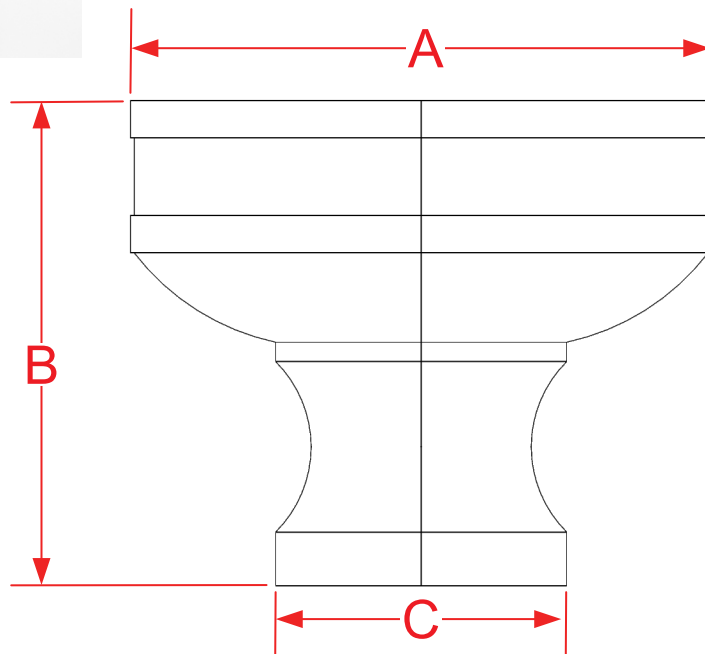

	A	B	C
Part #	Diameter	Projection	Base
580	1.0000"	1.0625"	0.5000"
581	1.2500"	1.1250"	0.6250"
582	1.5000"	1.1875"	0.7880"
Custom Sizing Available			



Manufacturing Fine Architectural Hardware
in the USA Since 1927

