

# 583, 584 & 585 Cabinet Knobs Series

Finishes for Life  
TARNISH-FREE GUARANTEED

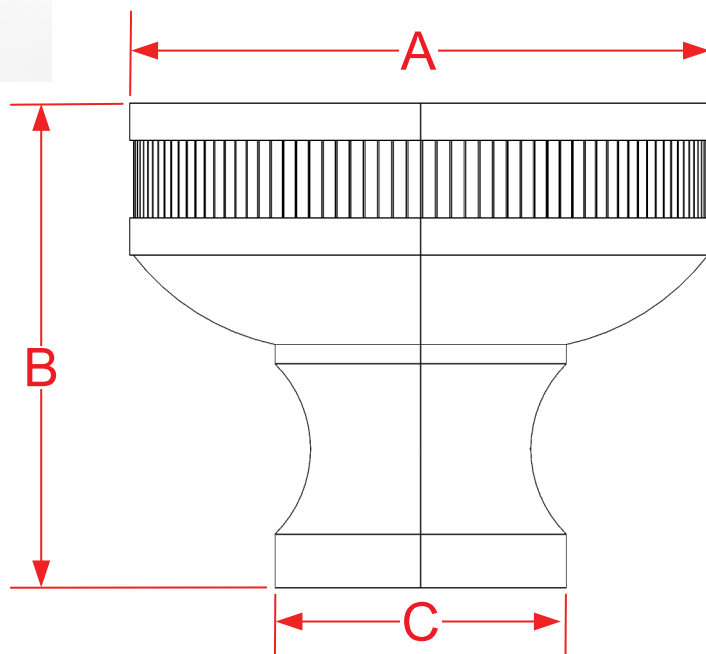

	A	B	C
Part #	Diameter	Projection	Base
583	1.0000"	1.0625"	0.5000"
584	1.2500"	1.1250"	0.6250"
585	1.5000"	1.1875"	0.7880"
Custom Sizing Available			



Manufacturing Fine Architectural Hardware  
in the USA Since 1927

