

# 623, 624 & 625 Cabinet Knobs Series

Finishes for Life  
TARNISH-FREE GUARANTEE

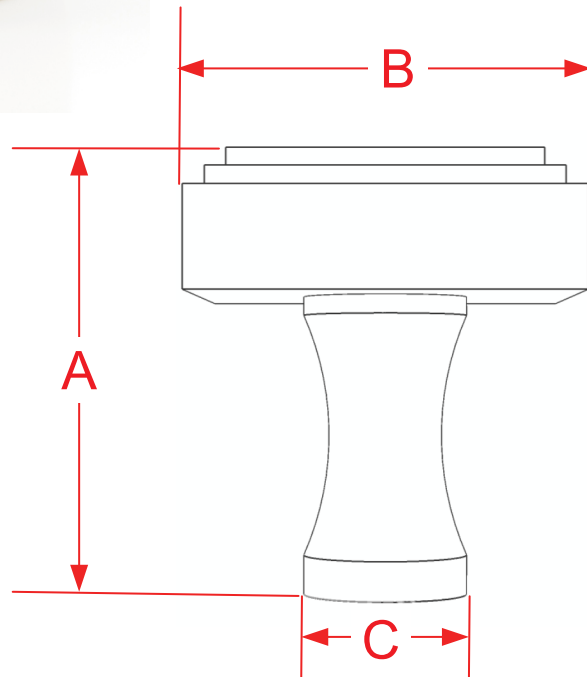

Part #	A Projection	B Diameter	C Base Diameter
623	1.1875"	1.0000"	0.4375"
624	1.1875"	1.2500"	0.4375"
625	1.1875"	1.5000"	0.4375"
Custom Sizing Available			



Manufacturing Fine Architectural Hardware  
in the USA Since 1927

