

Contemporary Lighting

PRODUCT NAME: Orbital
ITEM NUMBER: E23172-BKWT

Please consult your electrician for hanging fixture and wiring.

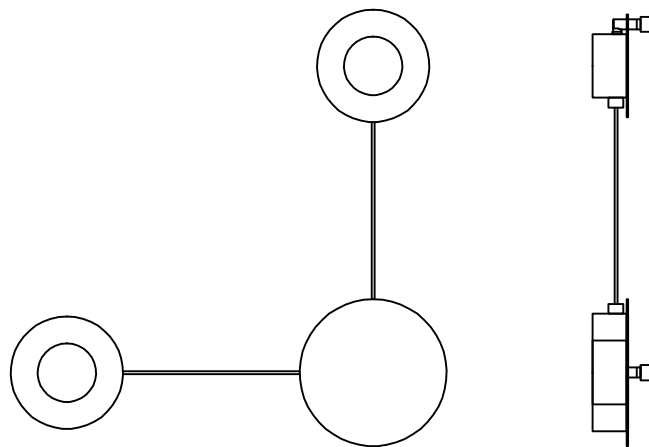

The fixture is designed to dim with a standard Triac forward phase dimmer. Dimming levels will vary by dimmer.

Below is a list of recommended dimmers:

- Lutron MACL-153M
- Lutron DVL-153P
- Lutron SCL-153P
- Leviton IPL06-10Z
- Leviton 6674-POW

Due to inrush current wattage should not exceed 150 watts of product for a 600 watt dimmer.

Warning! Wires need to be connected to driver found in canopy and should not be connected directly to power source or a short may occur.

Bulb(integrated):LED 4.8W

IMPORTANT: Turn off the power at the main fuse or circuit breaker box before starting installation

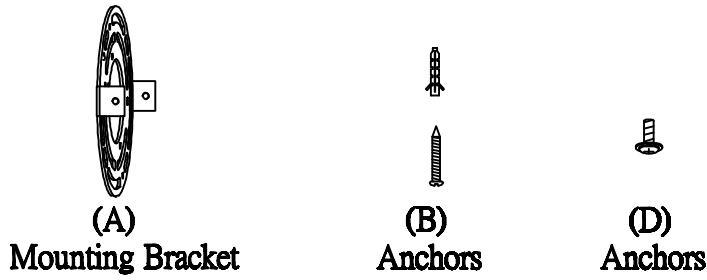

Locate all hardware & components before discarding packaging

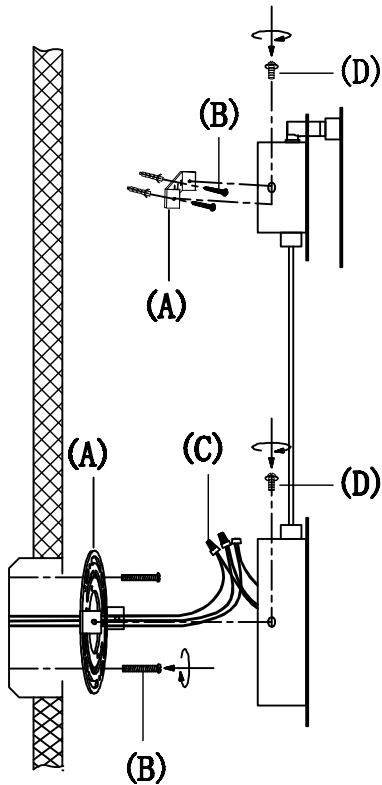

1.)

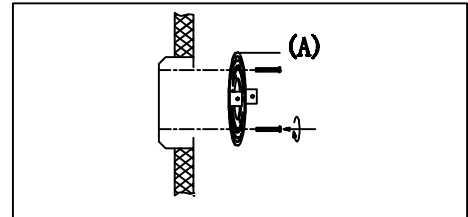

Step.1: Remove mounting bracket (A) from fixture and install to electrical box.

2.)

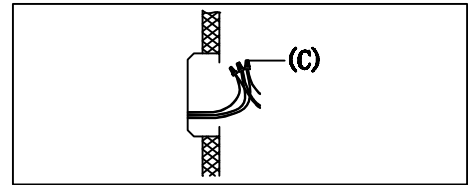

Step.2: Wire fixture to wires (C) in outlet box. Copper wire is for Ground.

3.)

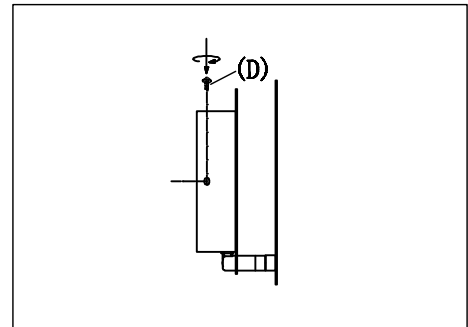

Step.3: Install fixture to bracket and tighten finials (D) at the ends of the canopy to secure.

4.)

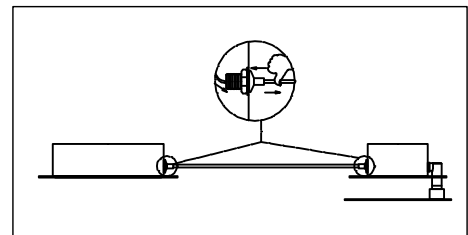

Step.4: Adjust wire length to desired mounting position. Fix the satellite wall lights to the wall using brackets.

Cleaning & Care:

Clean with soft cloth and a mild detergent.
Do not use abrasive cleaner.