

PRODUCT NAME: 4 SQUARE
ITEM NUMBER: E30582

Please consult your electrician for hanging fixture and wiring.

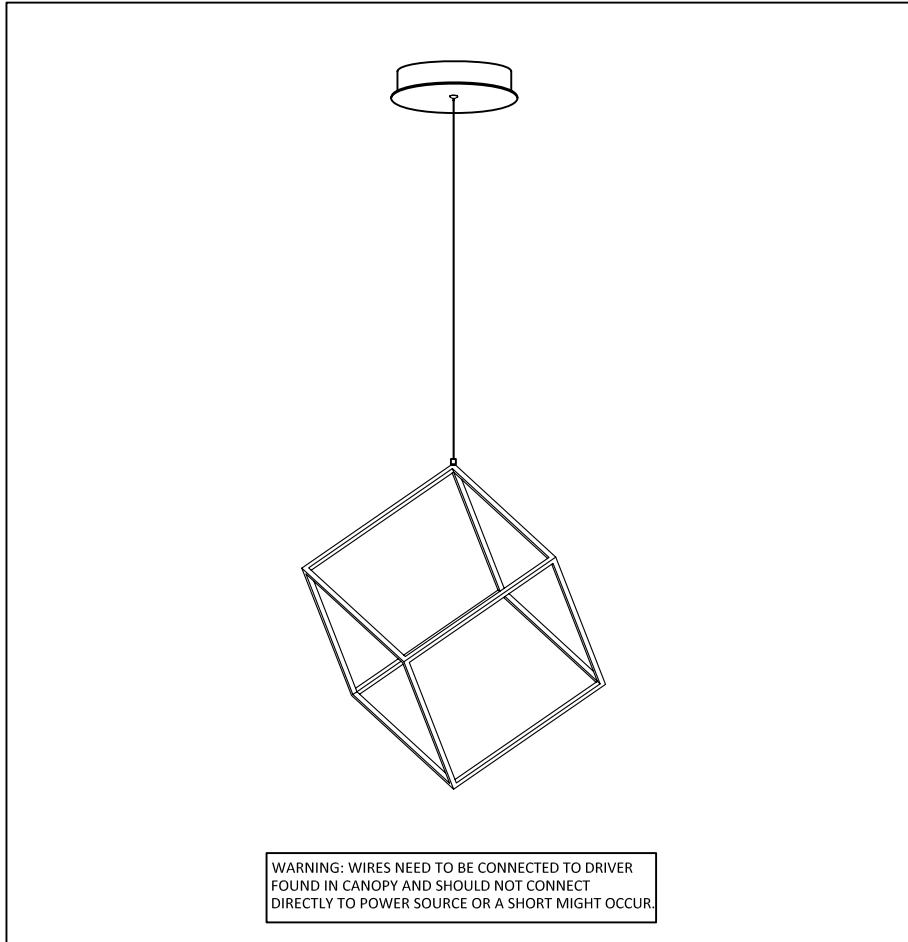

WARNING: WIRES NEED TO BE CONNECTED TO DRIVER FOUND IN CANOPY AND SHOULD NOT CONNECT DIRECTLY TO POWER SOURCE OR A SHORT MIGHT OCCUR.

Bulb (integrated): 24 Watts LED

IMPORTANT: Turn off the power at the main fuse or circuit breaker box before starting installation

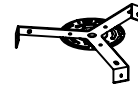

Bracket (A)

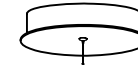

Canopy (B)

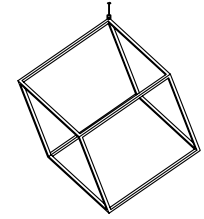

Body (C)

Locate all hardware & components before discarding packaging

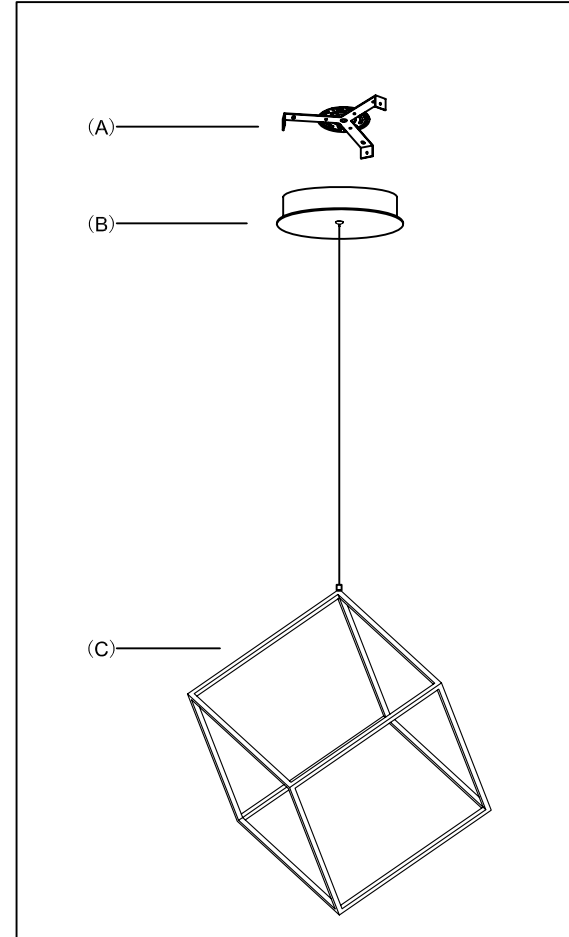

Cleaning & Care:
Clean with soft cloth and a mild detergent.
Do not use abrasive cleaner.

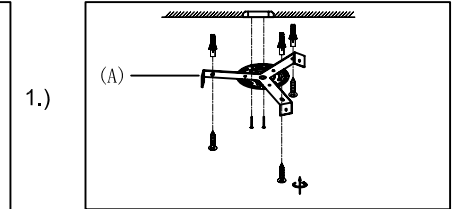

1.)

Step. 1: Remove Bracket (A) from fixture and install to electrical box.

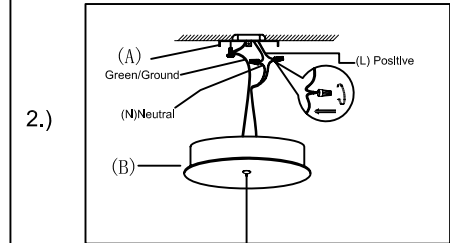

2.)

Step. 2: Wire fixture to wires in outlet box. Install Green wire to Ground Screw.

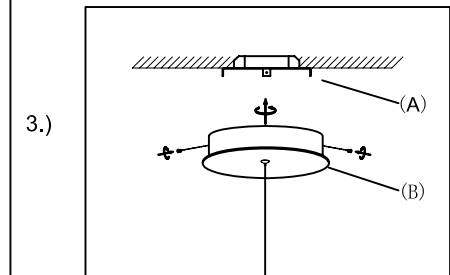

3.)

Step. 3: Adjust wire length to desired hanging height. Install Canopy (B) to Bracket (A) and tighten screws at the end of canopy to secure.