 PROPRIETARY AND CONFIDENTIAL THE INFORMATION CONTAINED IN THIS DRAWING IS THE SOLE PROPERTY OF HARDWARE RESOURCES INC. ANY REPRODUCTION IN PART OR AS A WHOLE WITHOUT THE WRITTEN PERMISSION OF HARDWARE RESOURCES INC. IS PROHIBITED.	ITEM:	COR8-2	MATERIAL:		
	FINISH:		WEIGHT:	[.2] g	
	TOLERANCE UNLESS OTHERWISE SPECIFIED: X ±0.20 X.X ±0.10 X.XX ±0.05 ANGULAR: ±0.5°		UNITS:	DRAWN BY:	DATE:
	DO NOT SCALE DRAWING		SIZE:	APPROVED BY:	DATE:
		SHEET:	RELEASE LEVEL:	REVISION:	
		PROJECTION 		DATE: Aug-08-16	

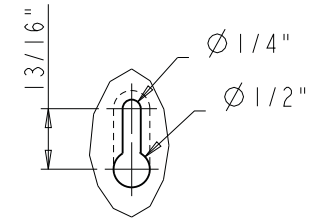
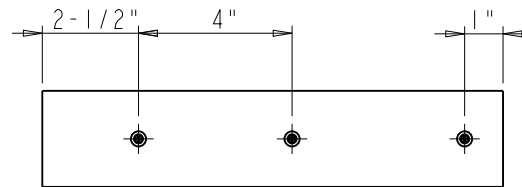
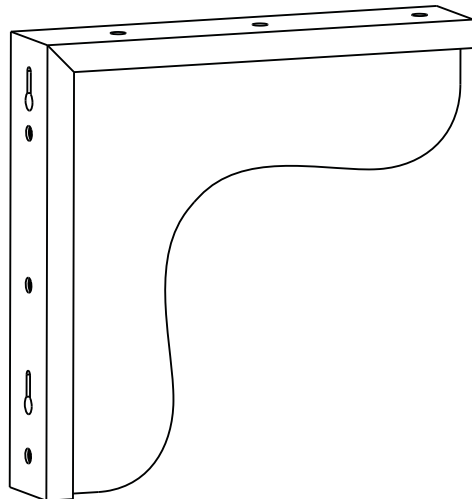
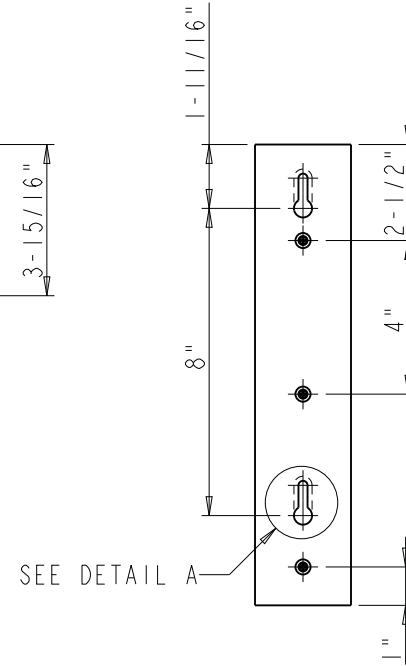
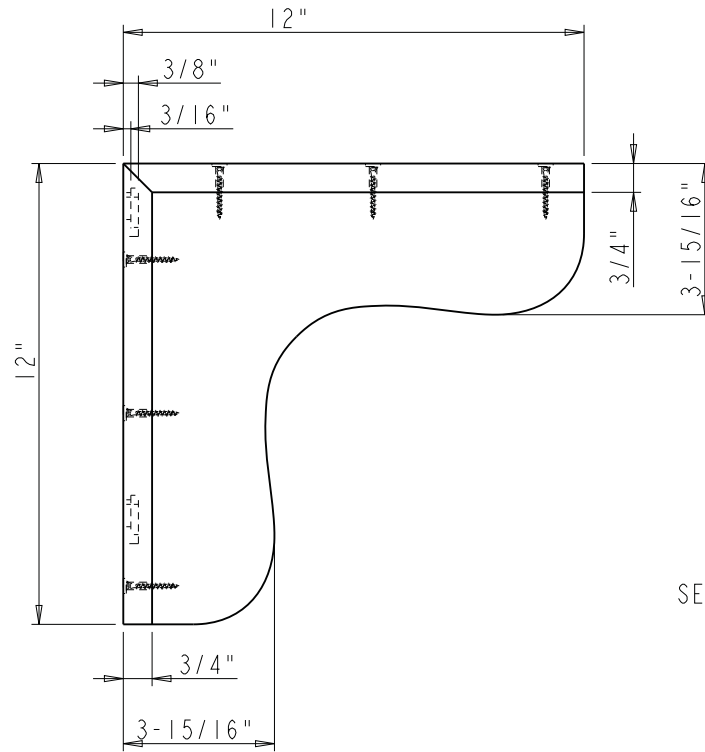
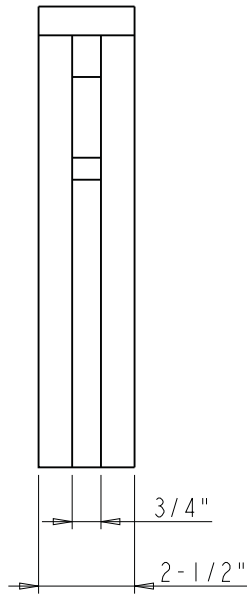

DETAIL A
SCALE 2:5

<p>hardware resources</p> <p>PROPRIETARY AND CONFIDENTIAL</p> <p>THE INFORMATION CONTAINED IN THIS DRAWING IS THE SOLE PROPERTY OF HARDWARE RESOURCES INC. ANY REPRODUCTION IN PART OR AS A WHOLE WITHOUT THE WRITTEN PERMISSION OF HARDWARE RESOURCES INC. IS PROHIBITED.</p> <p>DO NOT SCALE DRAWING</p>	ITEM:	COR8-2	MATERIAL:	
	FINISH:		WEIGHT:	
	TOLERANCE UNLESS OTHERWISE SPECIFIED:	UNITS:	DRAWN BY:	DATE:
	SIZE:	APPROVED BY:	DATE:	
ANGULAR: ±0.5°	RELEASE LEVEL:	REVISION:		