

| ITEM NO. | PART NUMBER | Description | QTY. |
|----------|-------------|------------------------------|------|
| 1 | PLD210ST-O | OUTSIDE TRIM | 1 |
| 2 | PLD210ST-I | INSIDE TRIM | 1 |
| 3 | PLM260D | DUMMY LOCK FOR PL210 DUMMY | 1 |
| 4 | PL-OVSCR45 | OVAL HEAD M4 BREAKAWAY SCREW | 4 |
| 5 | SCR-WS6PL | WOOD SCREW #6 x 1 FOR PL | 4 |

Linnea[®]

PL210 DUMMY LOCK SET

1 3/4" DOOR THICKNESS

PL210 DUMMY LOCK SET

ALIGN WITH CENTER OF DOOR

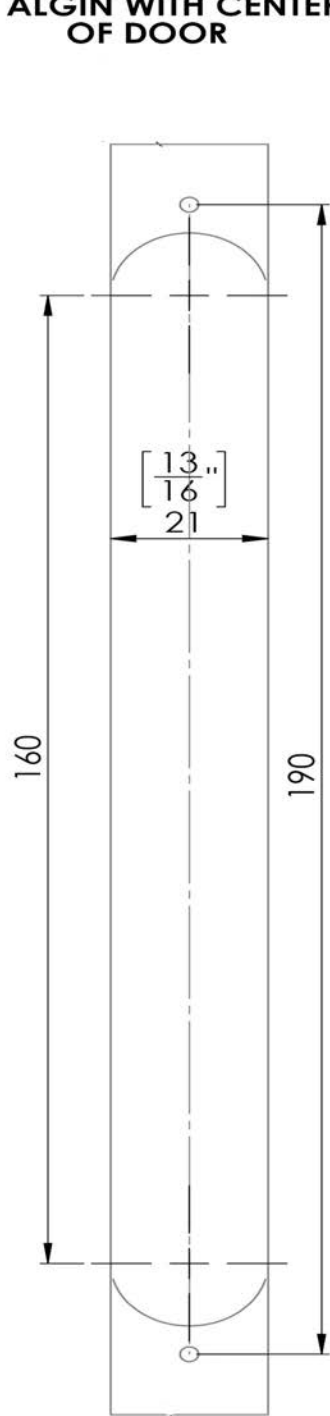

FOLD ALONG DOTTED LINE

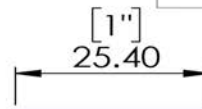
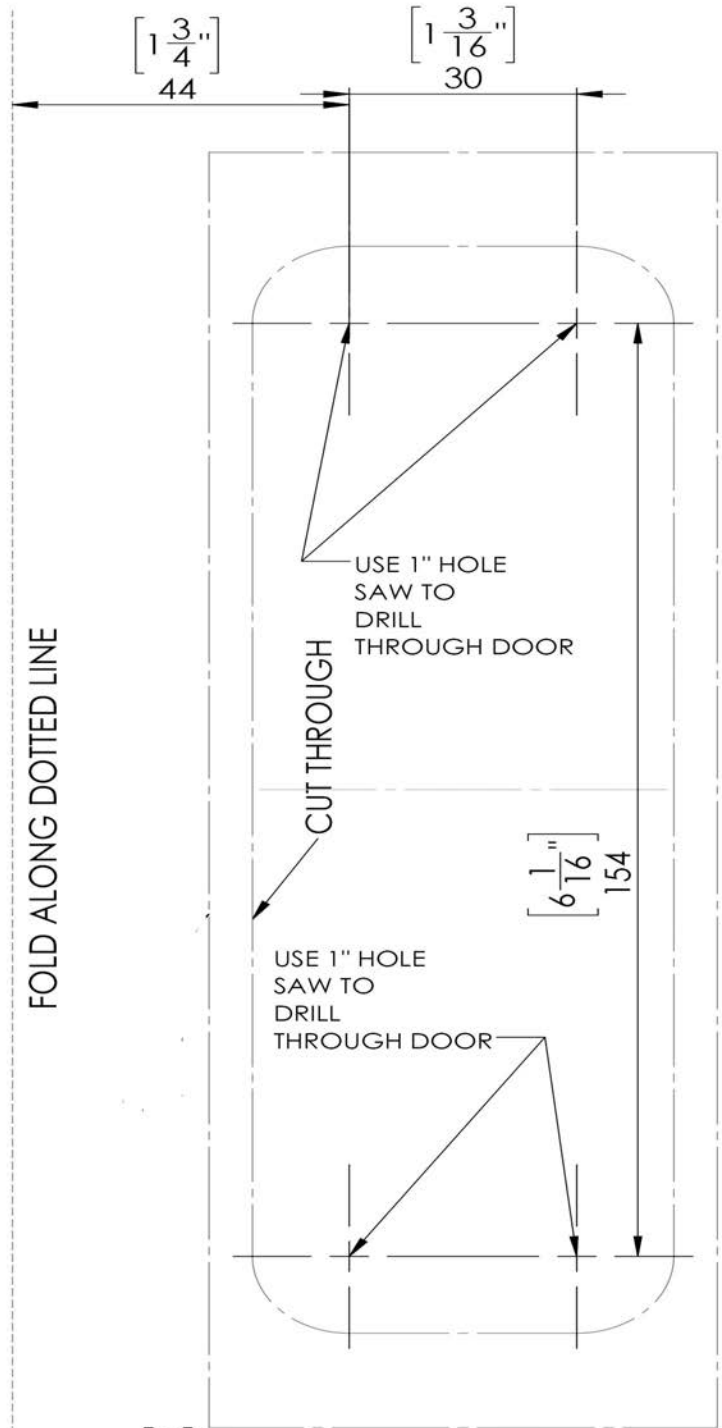

Linnea®

MEASUREMENTS ARE IN INCHES AND MILLIMETERS

INCHES ARE SHOWN IN []

PRINT THIS PAGE AT 100% SCALE

2" DOOR THICKNESS

PL210 DUMMY LOCK SET

ALIGN WITH CENTER OF DOOR

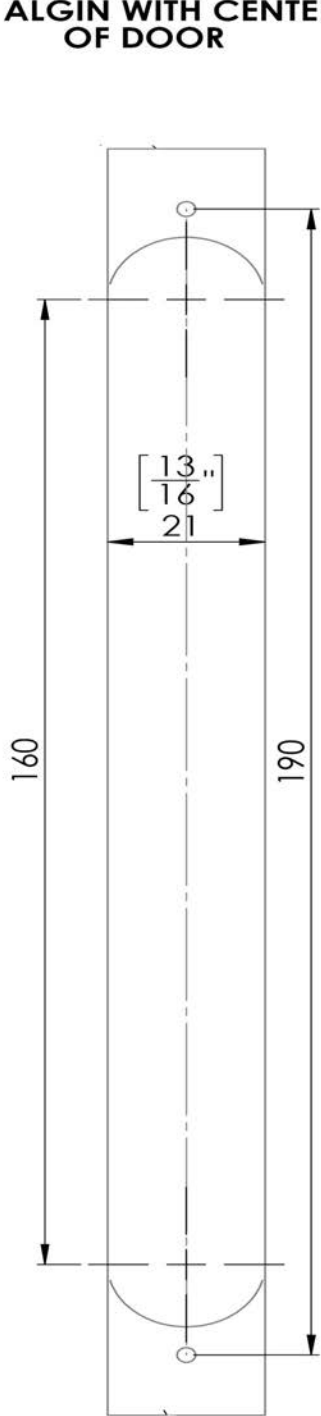

FOLD ALONG DOTTED LINE

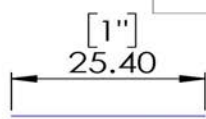
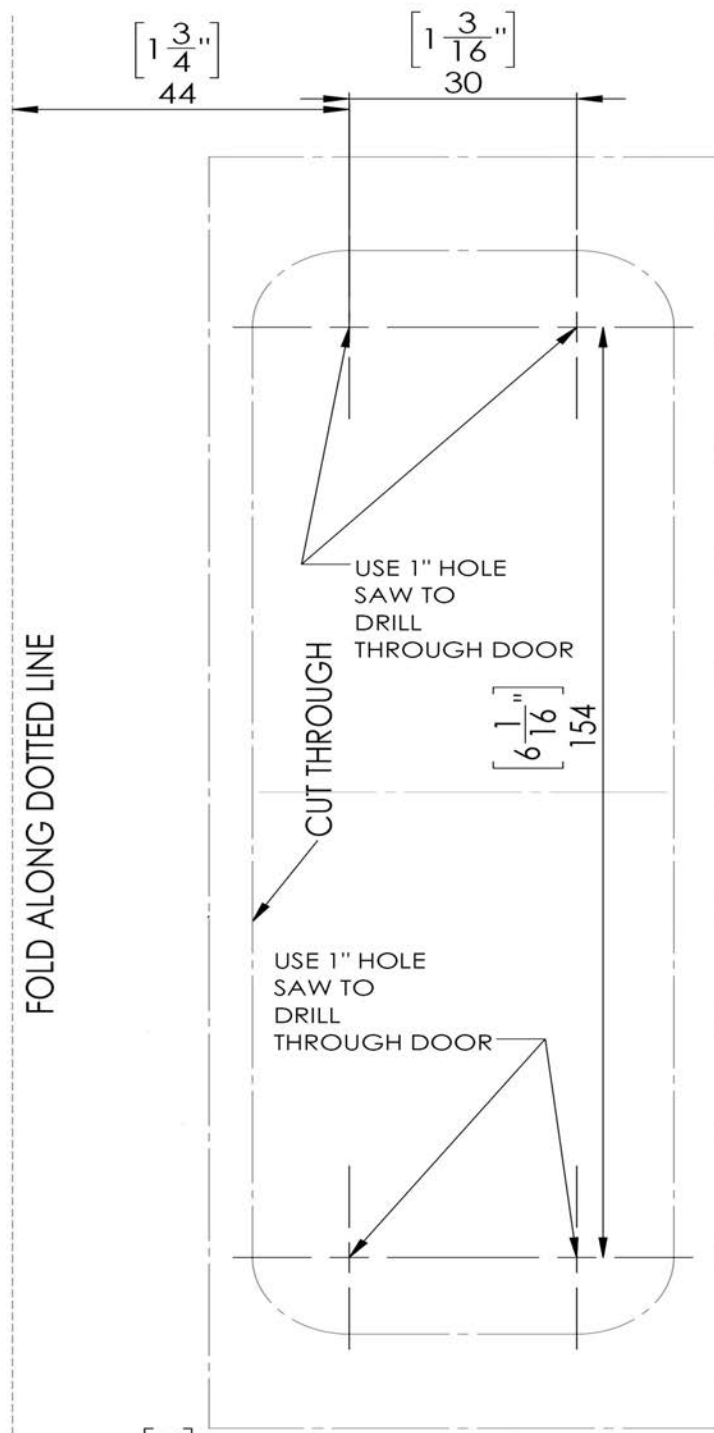

MEASUREMENTS ARE IN INCHES AND MILLIMETERS
INCHES ARE SHOWN IN []

PRINT THIS PAGE AT 100% SCALE

2 1/2" DOOR THICKNESS

PL210 DUMMY LOCK SET

ALIGN WITH CENTER OF DOOR

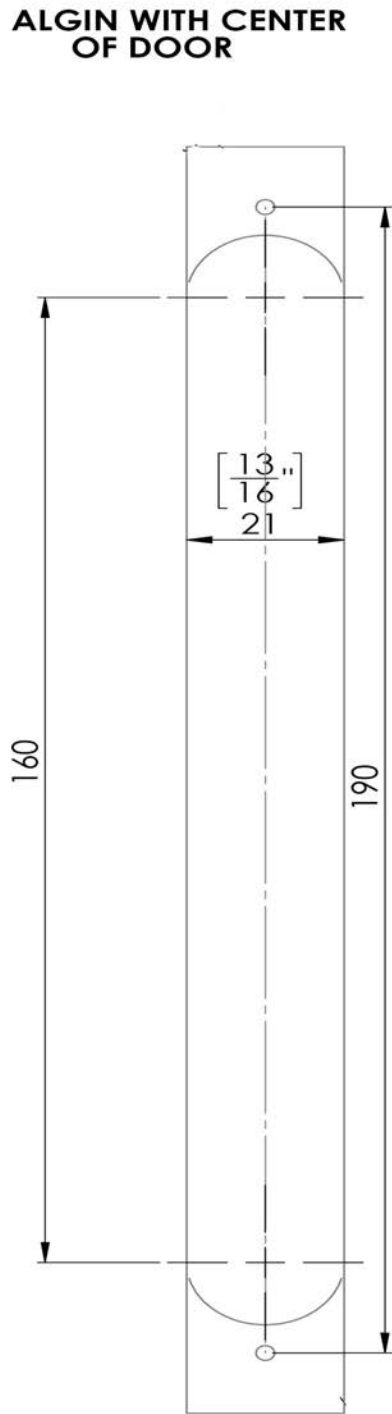

FOLD ALONG DOTTED LINE

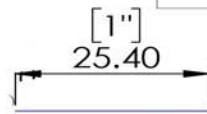
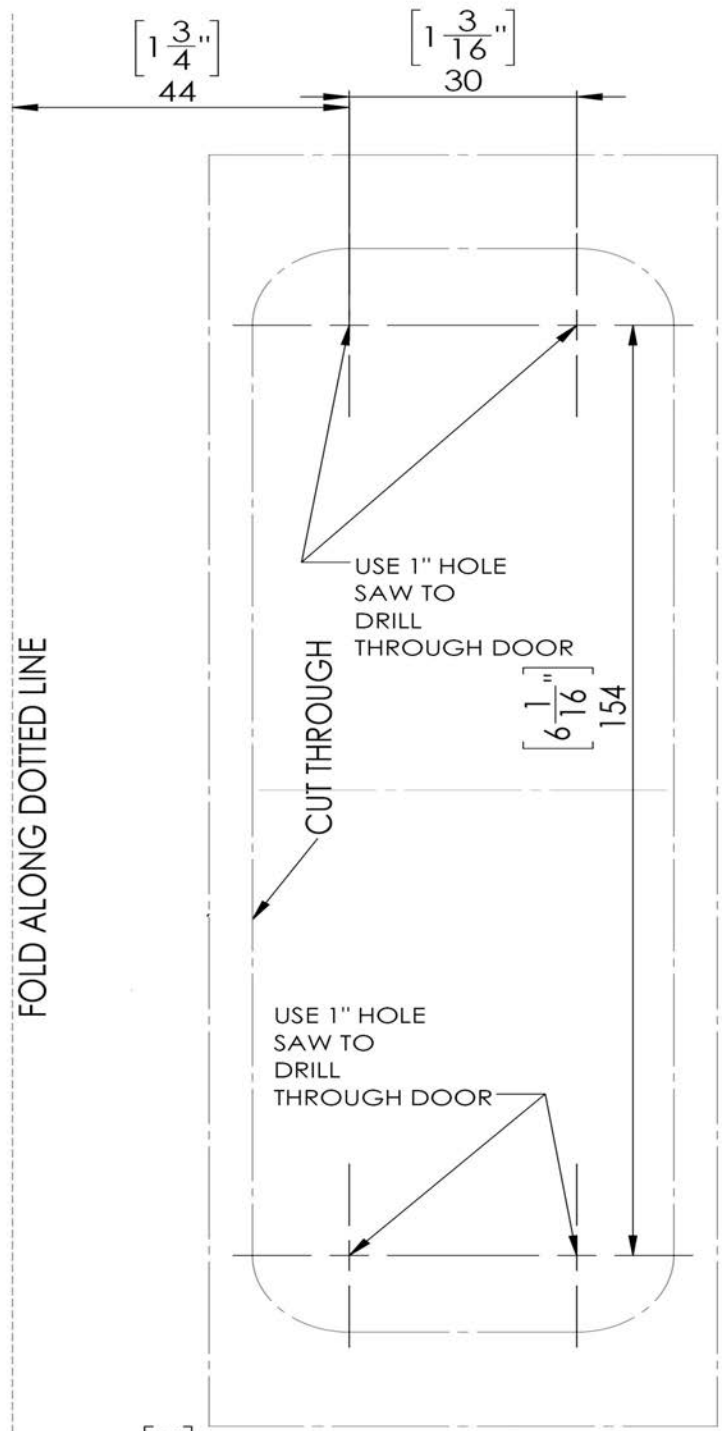

MEASUREMENTS ARE IN INCHES AND MILLIMETERS
INCHES ARE SHOWN IN []

Print paper template full scale.
Drill 3.175 mm [1/8"] on door center
943.4mm [37 9/64"] above floor

$1 \frac{3}{4}$
44

Print template full scale fold and position on door.
Use hole saw to drill 25.40 mm [1"] through door.
4 places as shown

$6 \frac{1}{16}$
154

$6 \frac{5}{16}$
160

CUT THROUGH DOOR

Use Paper template drill 21mm x 95mm deep hole

MORTISE LOCK BODY
95mm DEEP

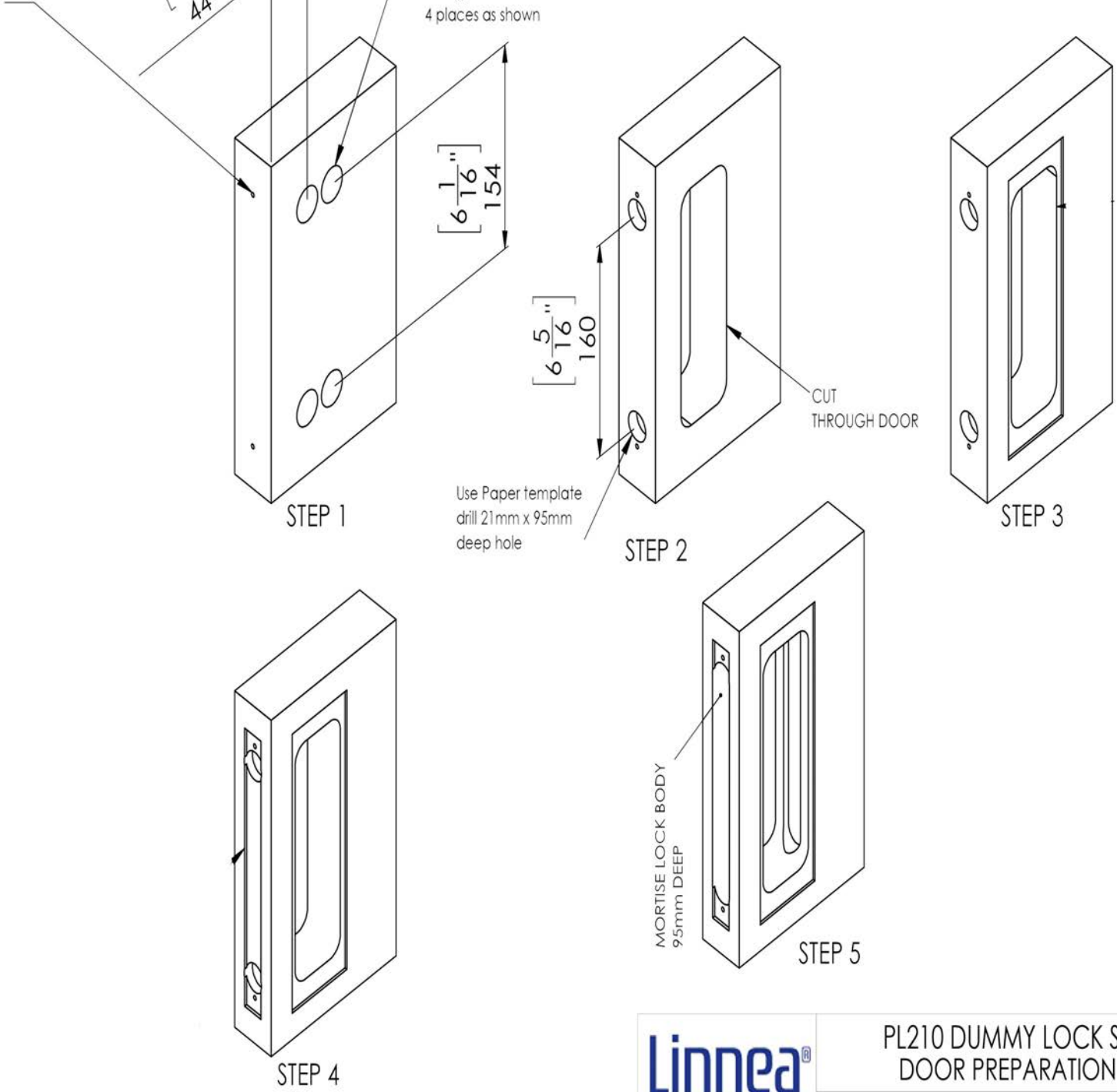

PL210 DUMMY LOCK SET
DOOR PREPARATION