

SECTION A-A

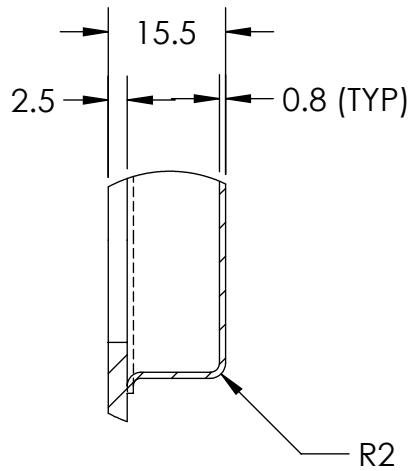

DETAIL B

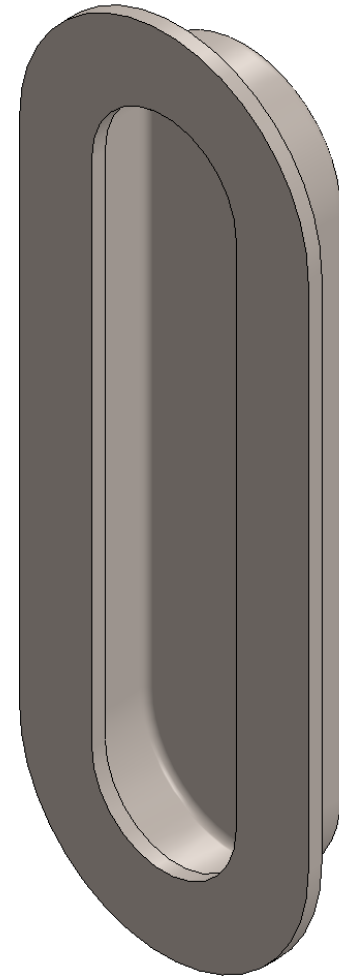

RPO-150
Linnea[®]