



Lighting Your Life Since 1970

Product Specifications - 3000CLBK

Job Name:	Job Type:
Quantity:	Comments:



3000CLBK
Builder Cast 1-Light Outdoor Wall Mount

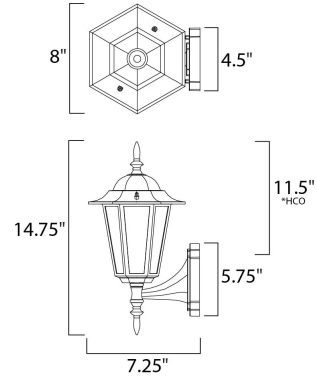

*Height from center of outlet to the top of the fixture

Finish
 Black

Glass/Shade
 Clear

Product Category
 Outdoor Wall Mount

Lamping

Number of Bulbs	1
Light Type	Incandescent
Bulb Type	MB
Max Bulb Wattage	100
Max Fixture Wattage	100
Rated Life	±2,500 Hours
Rated Lumens	±1,150
Color Temp	±2,700 K
Bulb(s)	Not Included
Light Up/Down	N/A
Beam Spread	N/A
CRI	N/A
Photo Cell Included	N/A
Ballast/Driver/Transformer	No
Dimmable	Standard

Measurements

Width	8.00"
Height	14.75"
Length	N/A
Extension	8"
Back Plate Width	4.50"
Back Plate Height	5.75"
HCO	11.50"
Min Overall Height	0.00"
Max Overall Height	N/A
Hanging Weight	2.02 lbs
Height Adjustable	N/A
Slope	N/A
Chain Length	N/A
Wire Length	N/A
Canopy Width	N/A
Canopy Height	N/A
Canopy Length	N/A

Shipping

Carton Weight	3.56 lbs
Carton Width	8"
Carton Height	12"
Carton Length	9"
Carton Cubic Feet	0.54
Master Pack	6
Master Pack Weight	21.38 lbs
Master Pack Width	19.69"
Master Pack Height	13.00"
Master Pack Length	25.20"
Master Cubic Feet	3.73
UPS Shippable	Yes

Certification

Safety Rating	Wet
Energy Star	No
CA Title 24	No
CA Title 20	No
ADA	No
Dark Sky	N/A

Other

UPC Code	783209300033
Shades Included	N/A
Crystals Included	N/A
Diffuser Included	N/A
Conversion Kit	N/A
Material	Die Cast Aluminum

Equivalents

Incandescent Watts	N/A
Fluorescent Watts	N/A

Maxim Lighting International and all designs, logos and images © 2015 Maxim Lighting International. All Rights Reserved. Maxim Lighting International reserves the right, at any time, to make changes in the design and/or construction of the product including the discontinuation of product without prior notice. Color may vary from what is pictured above due to limitations inherent to photographic processes.

Always consult a qualified, licensed electrician before installation of any product weighing 35 pounds or more. We recommend that a qualified, licensed electrician do the installation. Always install to a mechanically sound structure.