



Lighting Your Life Since 1970

Product Specifications - 40496WGOB

Job Name:	Job Type:
Quantity:	Comments:



40496WGOB
Carriage House VX 2-Light Outdoor Wall Lantern

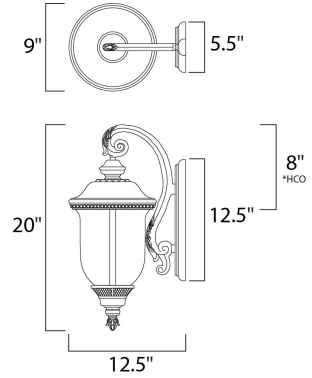

*height from center of outlet to the top of the fixture

Finish

Oriental Bronze

Glass/Shade

Water Glass

Product Category

Outdoor Wall Mount

Lamping

Number of Bulbs	2
Light Type	Incandescent
Bulb Type	CA
Max Bulb Wattage	60
Max Fixture Wattage	120
Rated Life	±1,500 Hours
Rated Lumens	±1,344
Color Temp	±2,700 K
Bulb(s)	Not Included
Light Up/Down	N/A
Beam Spread	N/A
CRI	N/A
Photo Cell Included	N/A
Ballast/Driver/Transformer	No
Dimmable	Standard Dimmer

Measurements

Width	9.00"
Height	20.00"
Length	N/A
Extension	13"
Back Plate Width	5.50"
Back Plate Height	12.50"
HCO	8.00"
Min Overall Height	0.00"
Max Overall Height	N/A
Hanging Weight	9.04 lbs
Height Adjustable	N/A
Slope	N/A
Chain Length	N/A
Wire Length	N/A
Canopy Width	N/A
Canopy Height	N/A
Canopy Length	N/A

Shipping

Carton Weight	14.52 lbs
Carton Width	16"
Carton Height	12"
Carton Length	20"
Carton Cubic Feet	2.19
Master Pack	1
Master Pack Weight	N/A
Master Pack Width	N/A
Master Pack Height	N/A
Master Pack Length	N/A
Master Cubic Feet	N/A
UPS Shippable	Yes

Certification

Safety Rating	Wet
Energy Star	No
CA Title 24	No
CA Title 20	No
ADA	No
Dark Sky	N/A

Other

UPC Code	783209063129
Shades Included	N/A
Crystals Included	N/A
Diffuser Included	N/A
Conversion Kit	N/A
Material	Vivex

Equivalents

Incandescent Watts	N/A
Fluorescent Watts	N/A

Maxim Lighting International and all designs, logos and images © 2015 Maxim Lighting International. All Rights Reserved. Maxim Lighting International reserves the right, at any time, to make changes in the design and/or construction of the product including the discontinuation of product without prior notice. Color may vary from what is pictured above due to limitations inherent to photographic processes.

Always consult a qualified, licensed electrician before installation of any product weighing 35 pounds or more. We recommend that a qualified, licensed electrician do the installation. Always install to a mechanically sound structure.