

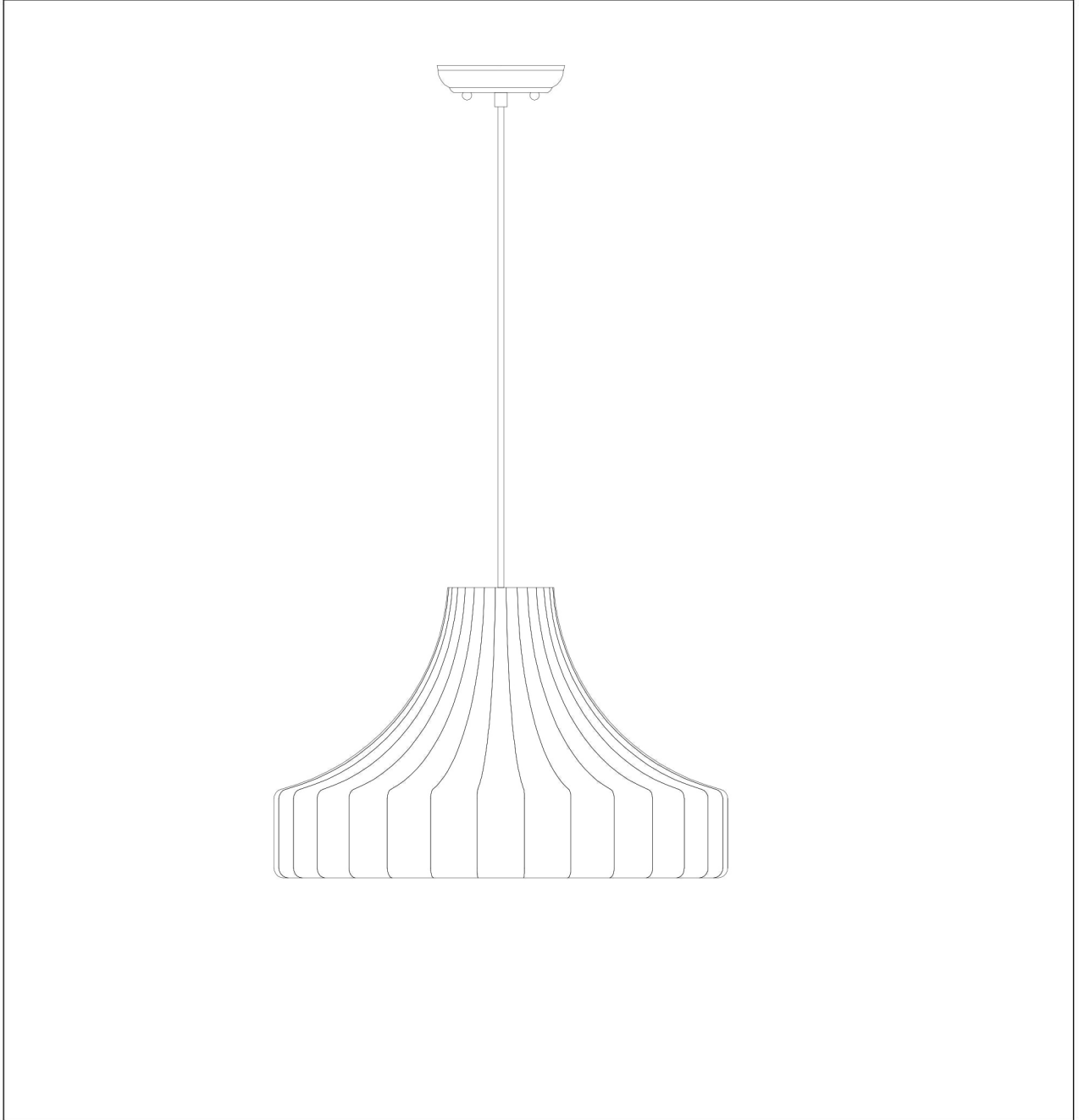

PRODUCT NAME: Cocoon 1-Light Pendant  
ITEM NUMBER:12187WTPC

Please consult your electrician for hanging fixture and wiring.



Bulb(not included):60W E26

**IMPORTANT:** Turn off the power at the main fuse or circuit breaker box before starting installation

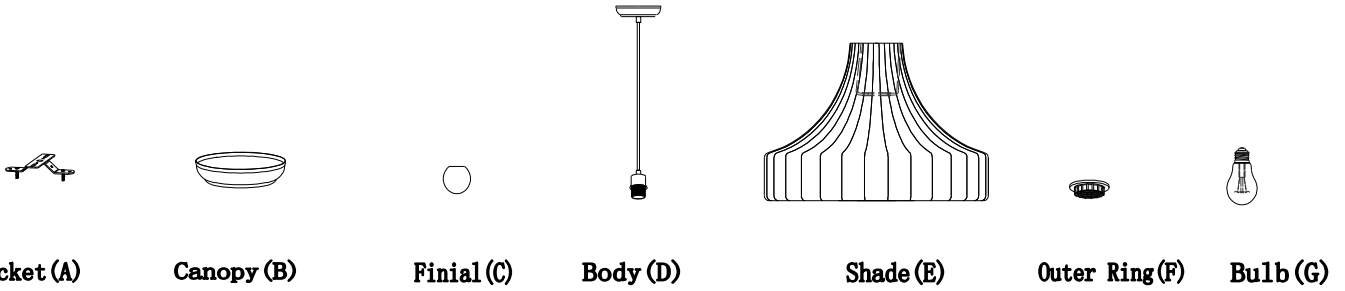

Locate all hardware & components before discarding packaging

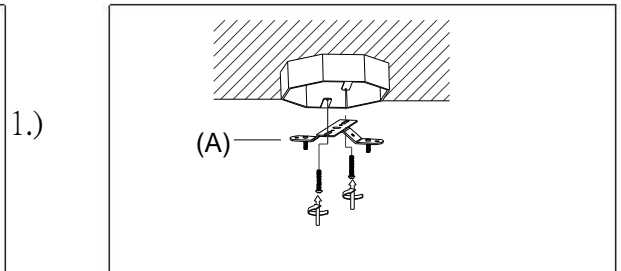
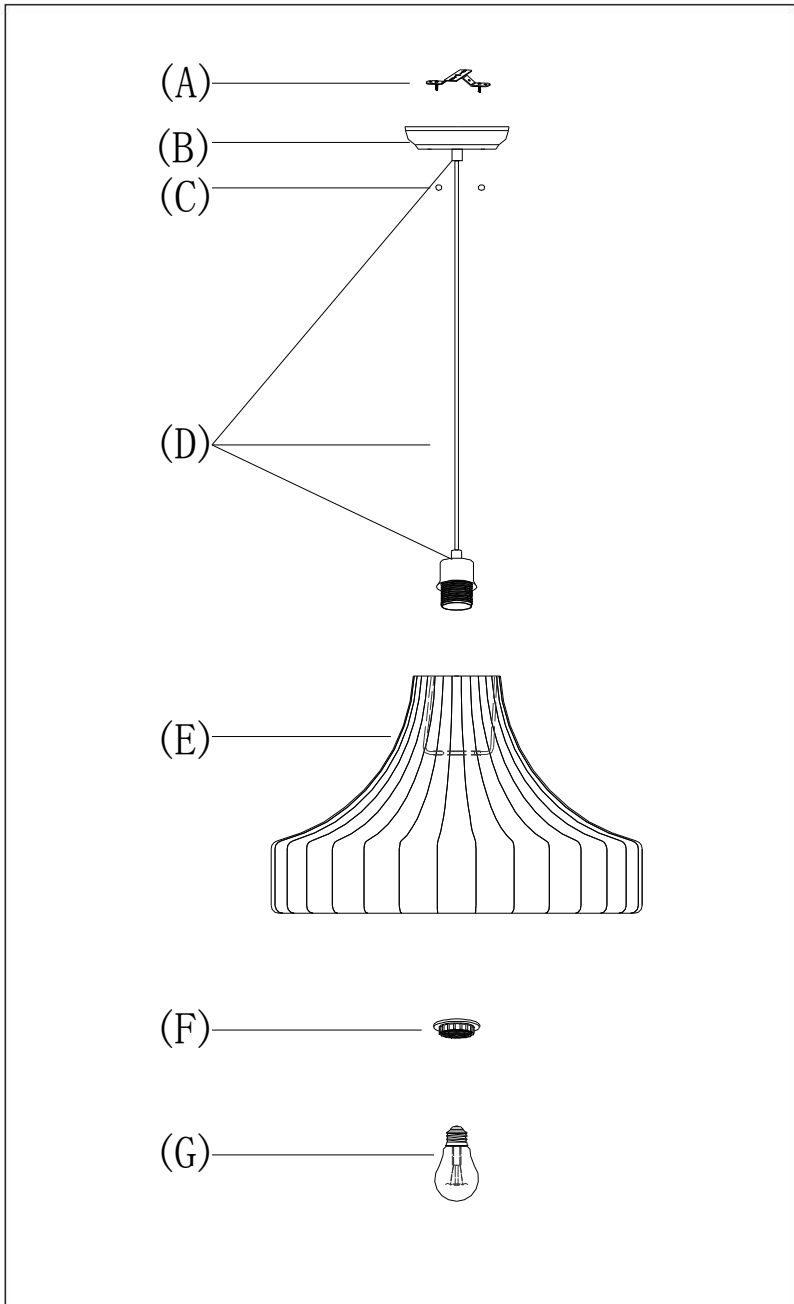

Step.1: Remove mounting bracket(A) from fixture and install to electrical box.

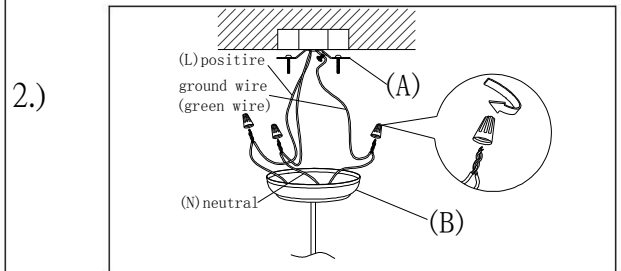

Step.2: Wire fixture to wires in outlet box. Green wire is for Ground.

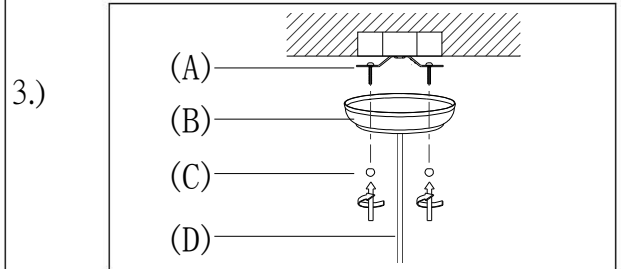

Step.3: Adjust wire length to desired mounting height, and tighten strain relief screws to secure. Install body(D) to bracket(A) and tighten finials (C) on the canopy (B) to secure.

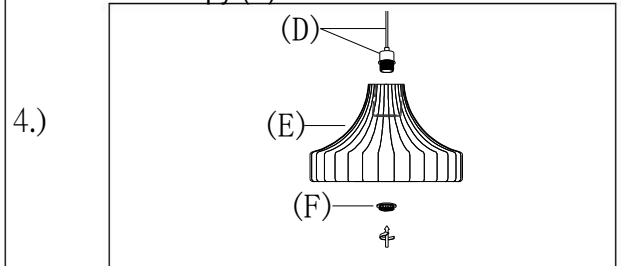

Step.4: Run socket through shade(E) and secure using screw ring(F) on socket. Screw in incandescent bulb(G). Remove plastic protection from Chrome lip at bottom of Shade.

**Cleaning & Care:**

Clean with soft cloth and a mild detergent.  
Do not use abrasive cleaner.