

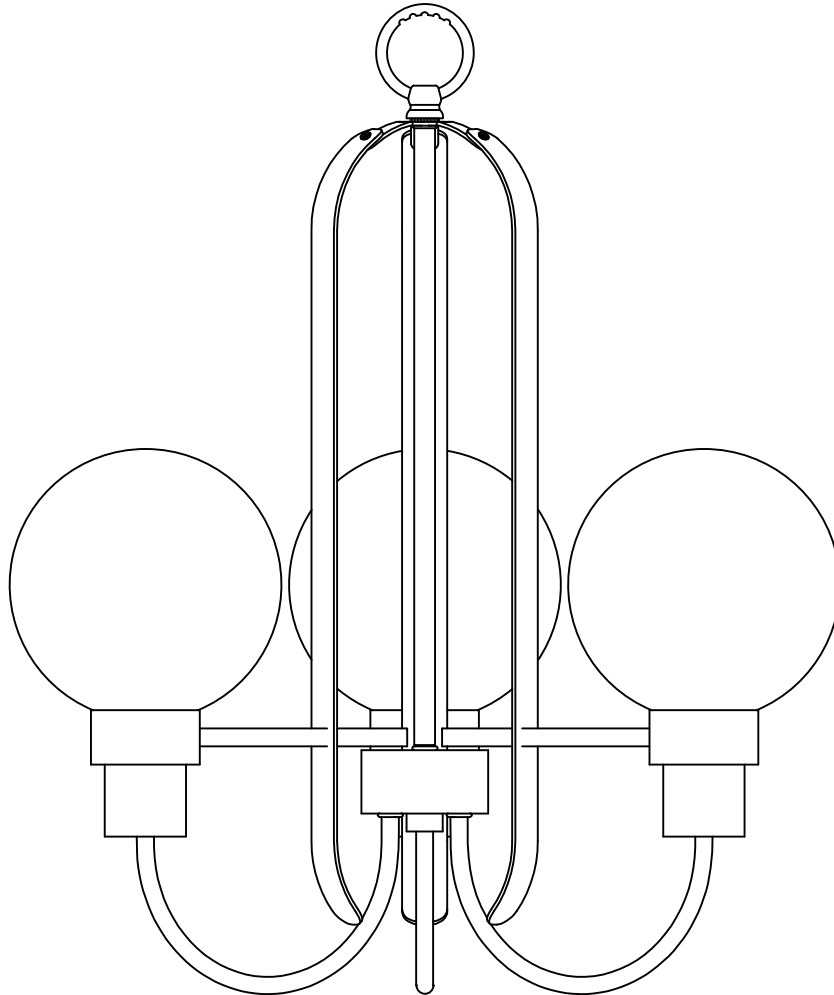

PRODUCT NAME : Bauhaus 3-Light Chandelier  
ITEM NUMBER: 30515CLBZSBR



**Please consult a qualified electrician for hanging fixture and wiring.**

Light Source : 3 X E12 Candelabra 60W (Not Included)

Made in China / Hecho en China / Fabrique en China





# EN Contents

Before getting started, ensure the package contains the following components:

Antes de comenzar, asegúrese de que el paquete contenga los siguientes componentes:

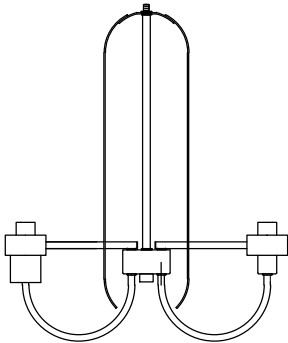
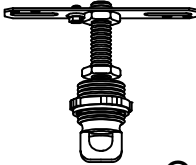
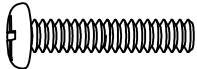
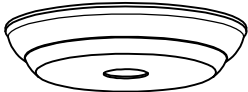
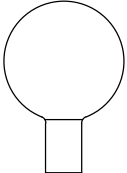
Avant de commencer, assurez-vous que le paquet contient les composants suivants:

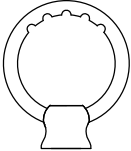
A		x1		
B		x1		
C		x2		
D		x1		
E		x3		
F		x1		
G		x1		

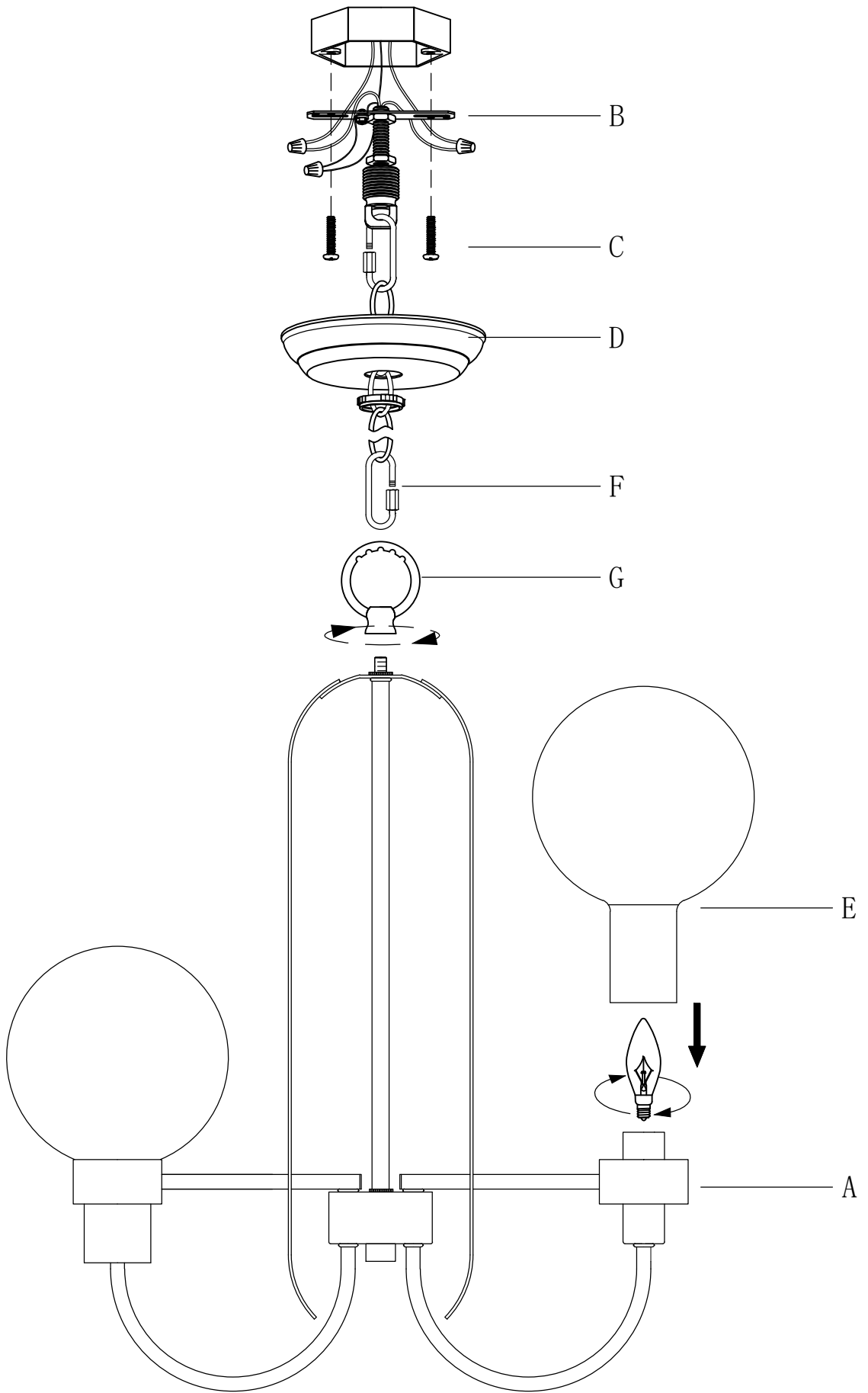

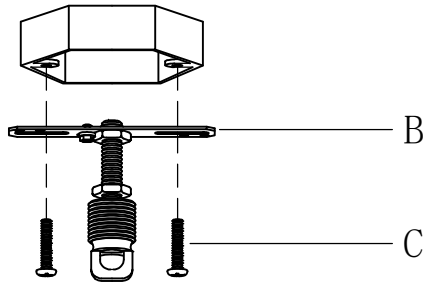

1.

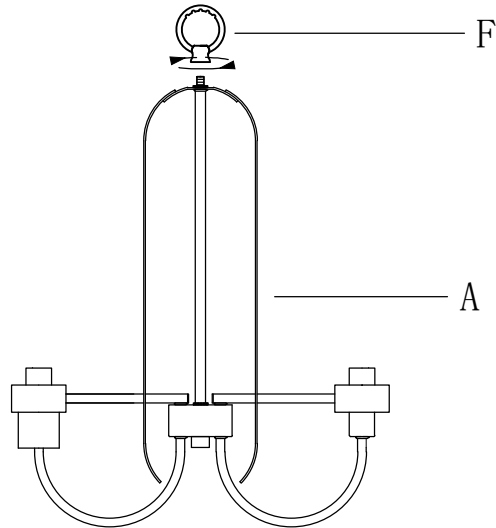

2.

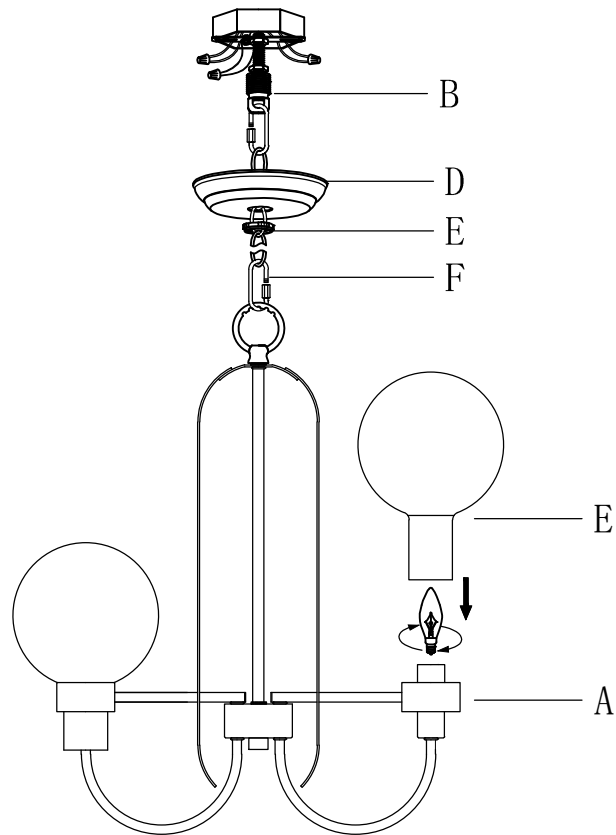

3.

Attach appropriate amount of chain to loop to achieve desired mounting height. Thread wire through every 3rd loop of chain. Remove ring from loop and slide down chain. Place canopy onto chain and let slide to top of fixture. Install nipple and cross bar into top of chain loop.