

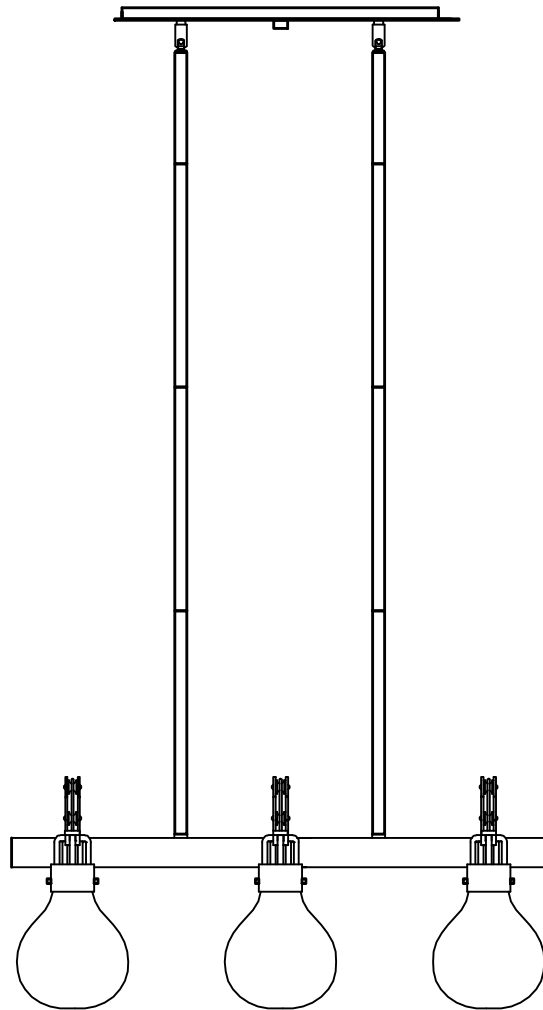

PRODUCT NAME: Kinetic LED 6-Light Linear Pendant
ITEM NUMBER: 39696CLDSN

Please consult your electrician for hanging fixture and wiring.



The fixture is designed to dim with a standard Triac forward phase dimmer. Dimming levels will vary by dimmer.

Below is a list of recommended dimmers:

Voici une liste de variateur recommandé :

Lutron MACL-153M

Lutron DVL-153P

Lutron SCL-153P

Leviton IPL06-10Z

Leviton 6674-POW

Due to inrush current wattage should not exceed 150 watts of product for a 600 watt dimmer.

Bulb(included) 6-PCB-6W

MADE IN CHINA
Page 1 of (3)

IMPORTANT: Turn off the power at the main fuse or circuit breaker box before starting installation

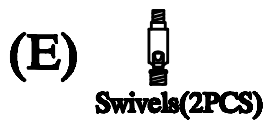
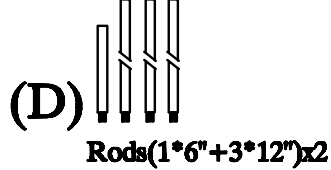
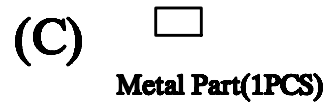
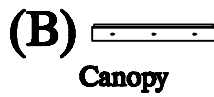

Locate all hardware & components before discarding packaging

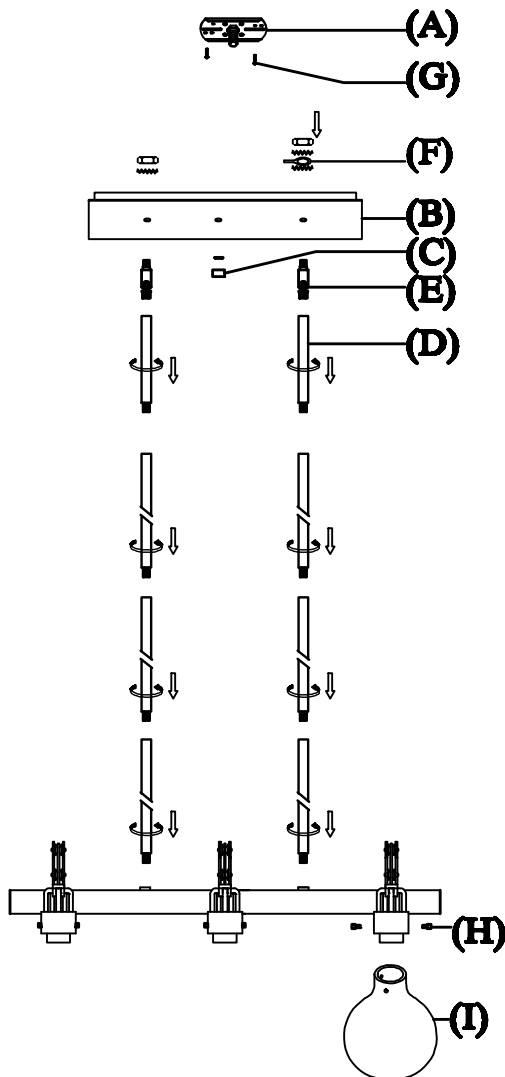

1.)

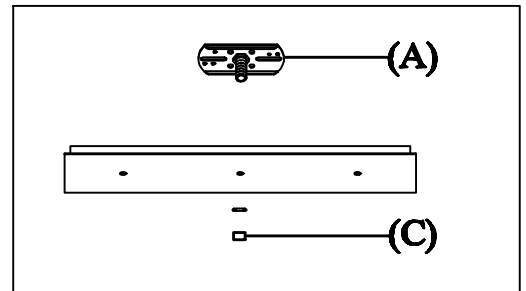

Step1:Remove mounting bracket from canopy.

2.)

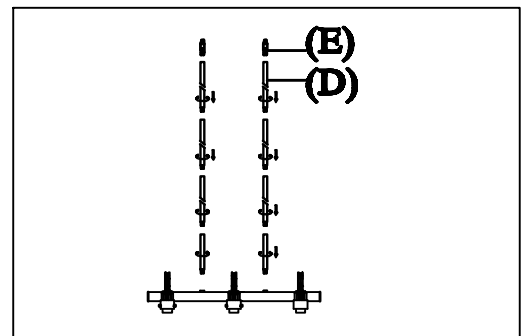

Step2:Run wire through stems and combine stem lengths to meet desired mounting height.

Cleaning & Care:

Clean with soft cloth and a mild detergent.
Do not use abrasive cleaner.

IMPORTANT: Turn off the power at the main fuse or circuit breaker box before starting installation



Locate all hardware & components before discarding packaging

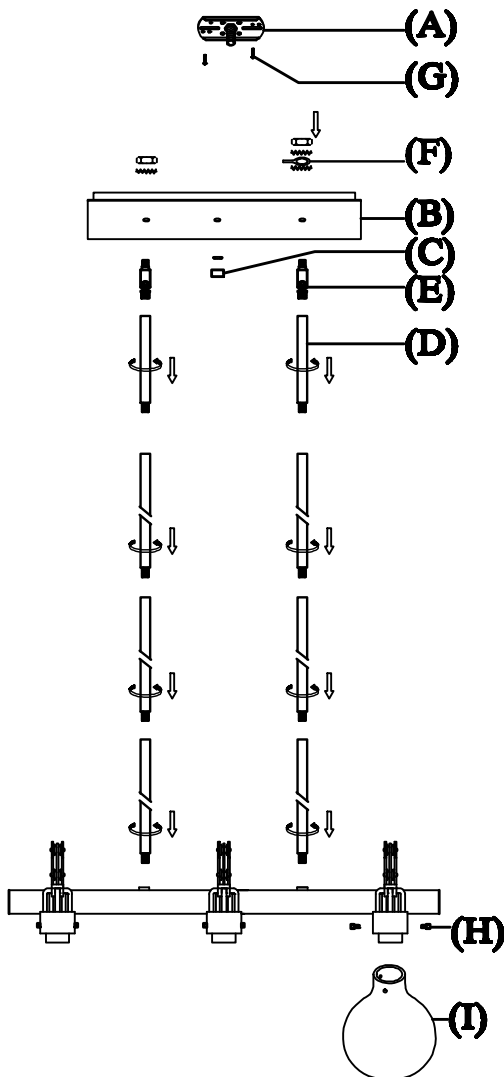

1.)

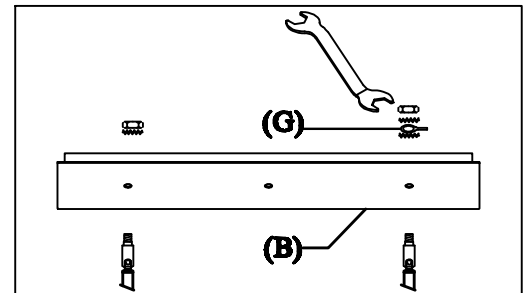

Step3:Secure the rod assembly to the set nipple of the canopy as shown in diagram.

2.)

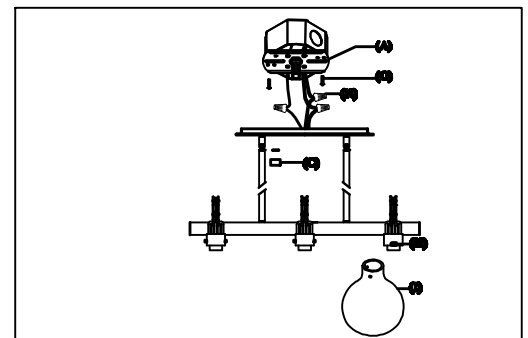

Step4:Install fixture to bracket and tighten ball nuts at the ends of the canopy to secure.

Cleaning & Care:

Clean with soft cloth and a mild detergent.
Do not use abrasive cleaner.