

1. Lay out glass by row beginning with bottom row 1. Glass is attached to cage by simply inserting hook onto horizontal bar and pull towards you until it locks.
2. Begin on bottom row 1, Space A and work counter clockwise until each row is complete. **Please note that enclosed diagram is a suggested layout. It is not critical to install exact. Glass size will vary so sometimes installing a piece on the next row down allows glass to stand more upright.**
3. Extra glass is supplied so if there is left over do not be concerned. If you can install extra on frame do so.

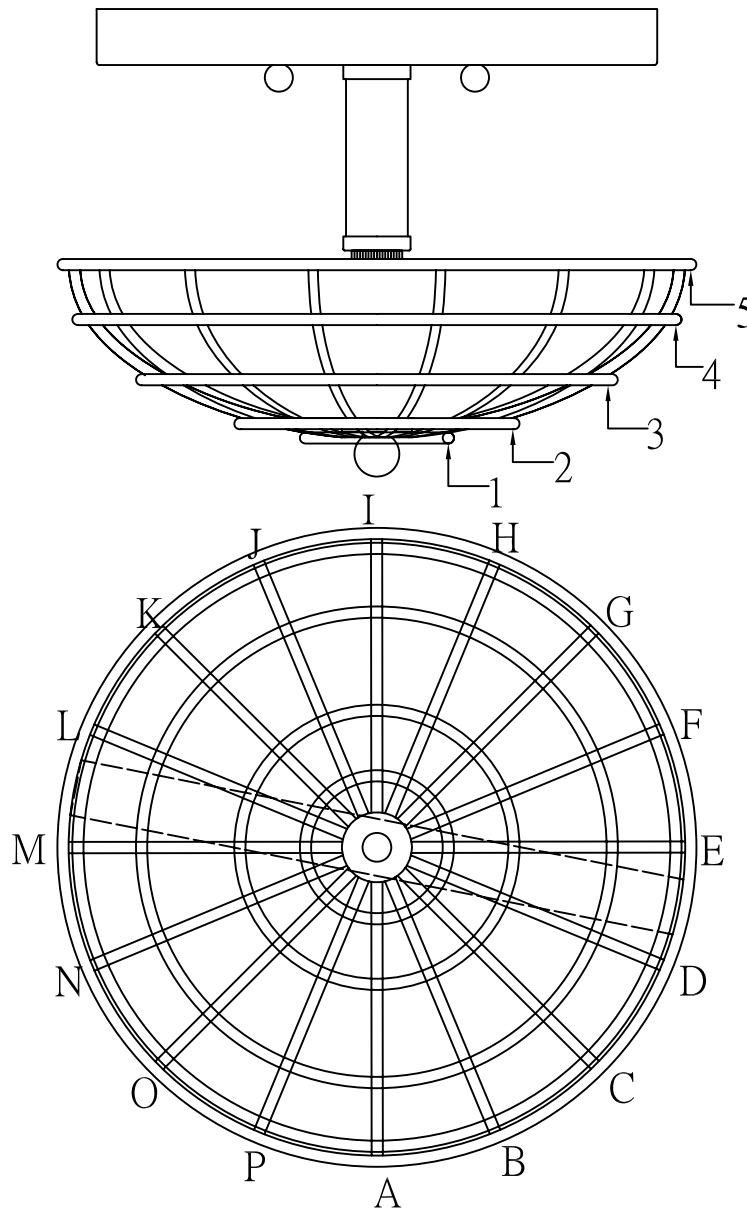

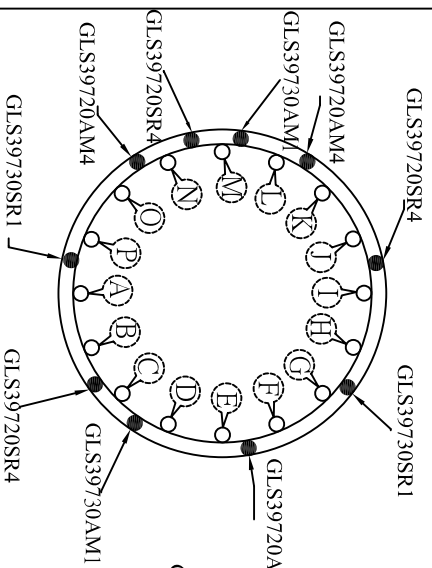

(1)

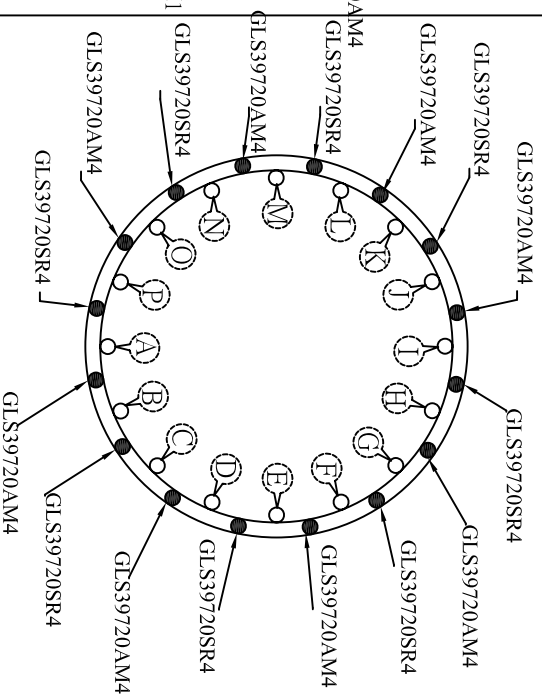

(2)

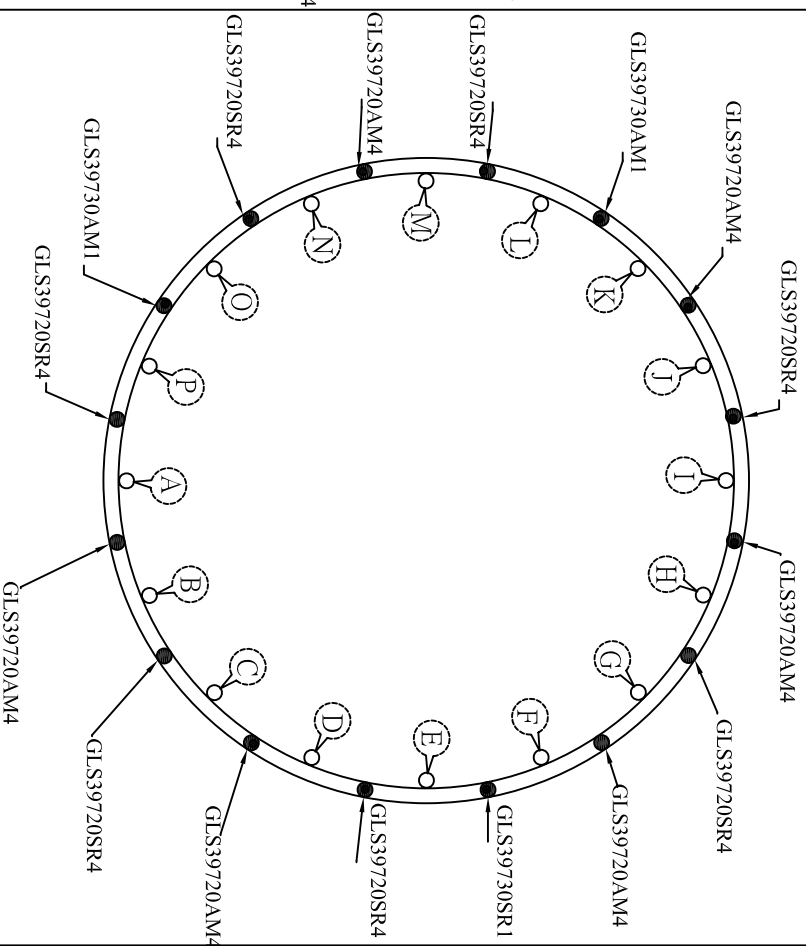

(3)

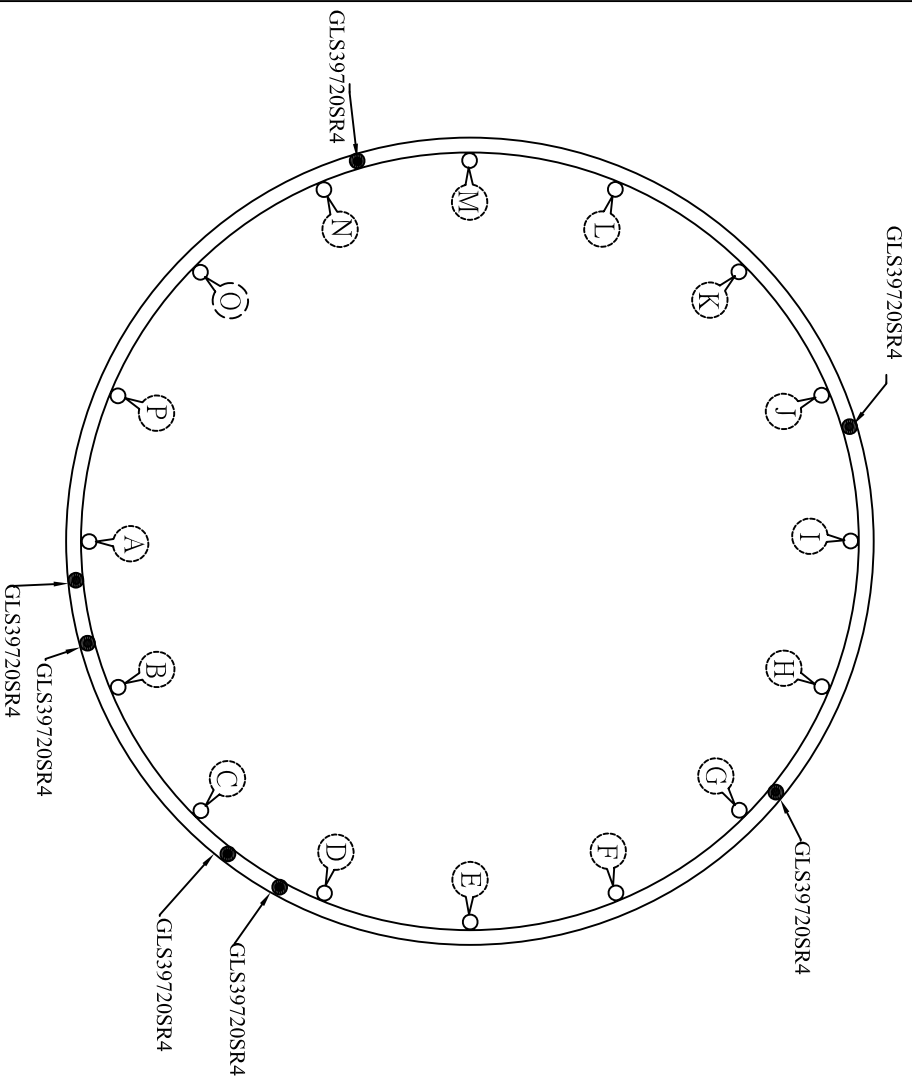

(4)

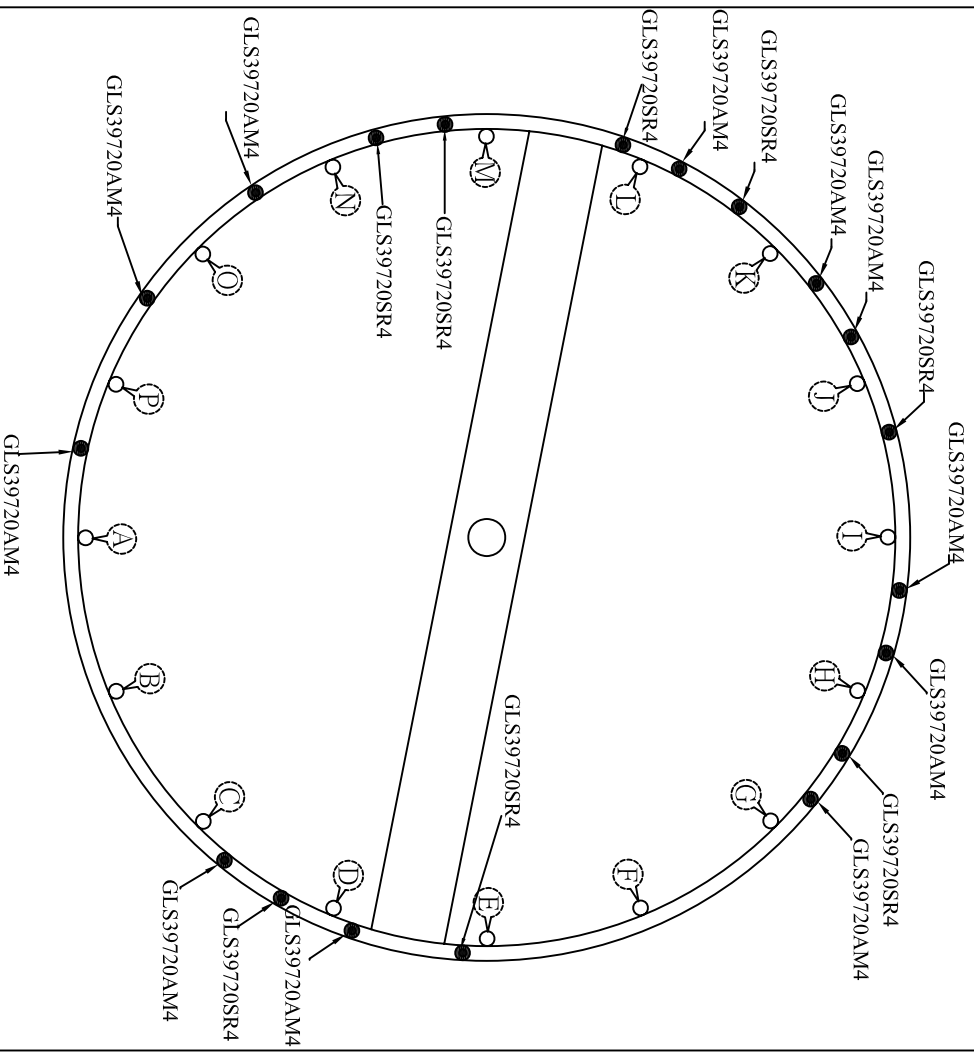

(5)

SR=Red Finish AM=Amber Finish

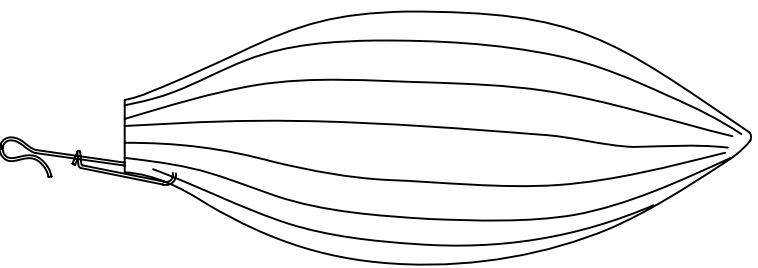

GLS39730SR1

GLS39730AM1

Glass size:3.25"W*8.25"H

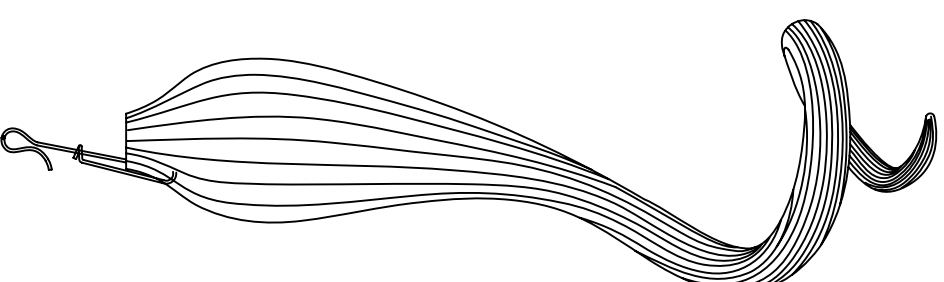

GLS39720AM4

GLS39720SR4

Glass size: 2.25"W* 10.5"H