

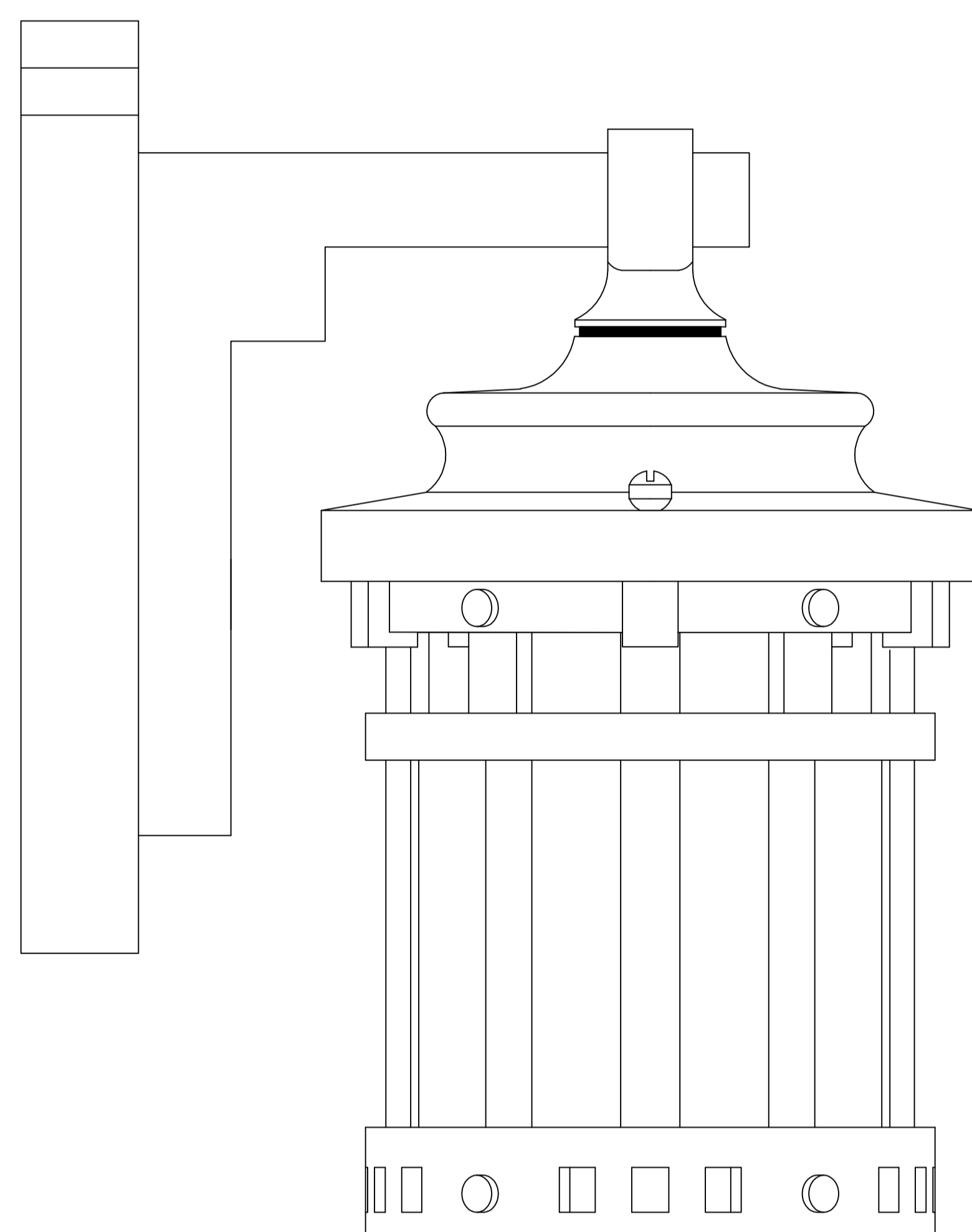

PRODUCT NAME: Santa Barbara
ITEM NUMBER: 65031

Please consult your electrician for hanging fixture and wiring.



To prevent water intrusion, caulk around back-plate where fixture meets the wall using outdoor silicone sealant. Leave a small gap at the bottom to allow moisture to exit.

Bulb(included): 1×9W E26 LED

MADE IN CHINA



PRODUCT NAME: Santa Barbara
 ITEM NUMBER: 65031

IMPORTANT: Turn off the power at the main fuse or circuit breaker box before starting installation.

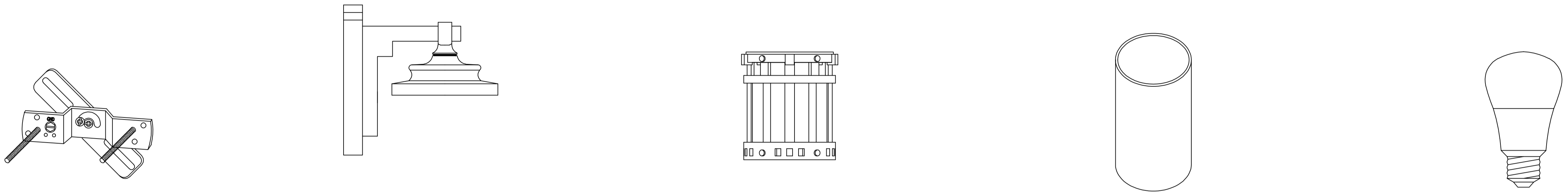

Bracket (A) Fixture (B) Cage (C) Glass shade (D) E26 LED Bulb (E)

Locate all hardware & components before discarding packaging

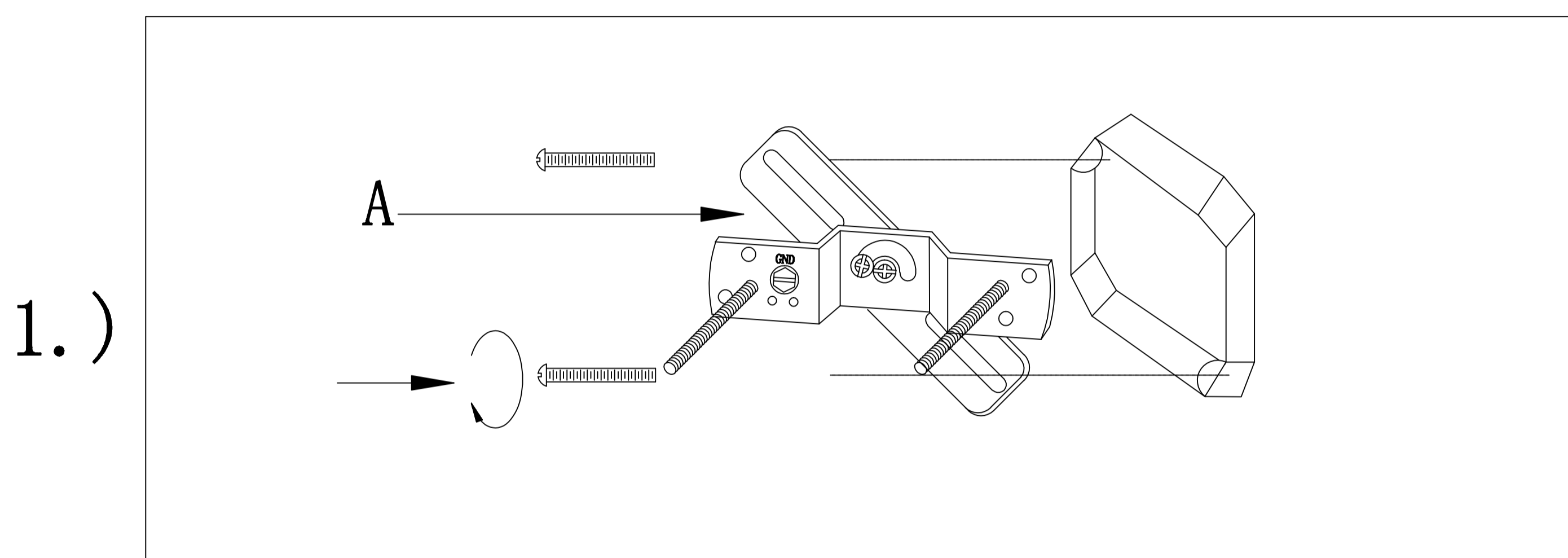

1.)

Step.1: Remove mounting bracket from fixture(B) and install to electrical box. then wire fixture to wires in outlet box. Copper wire is for Ground.

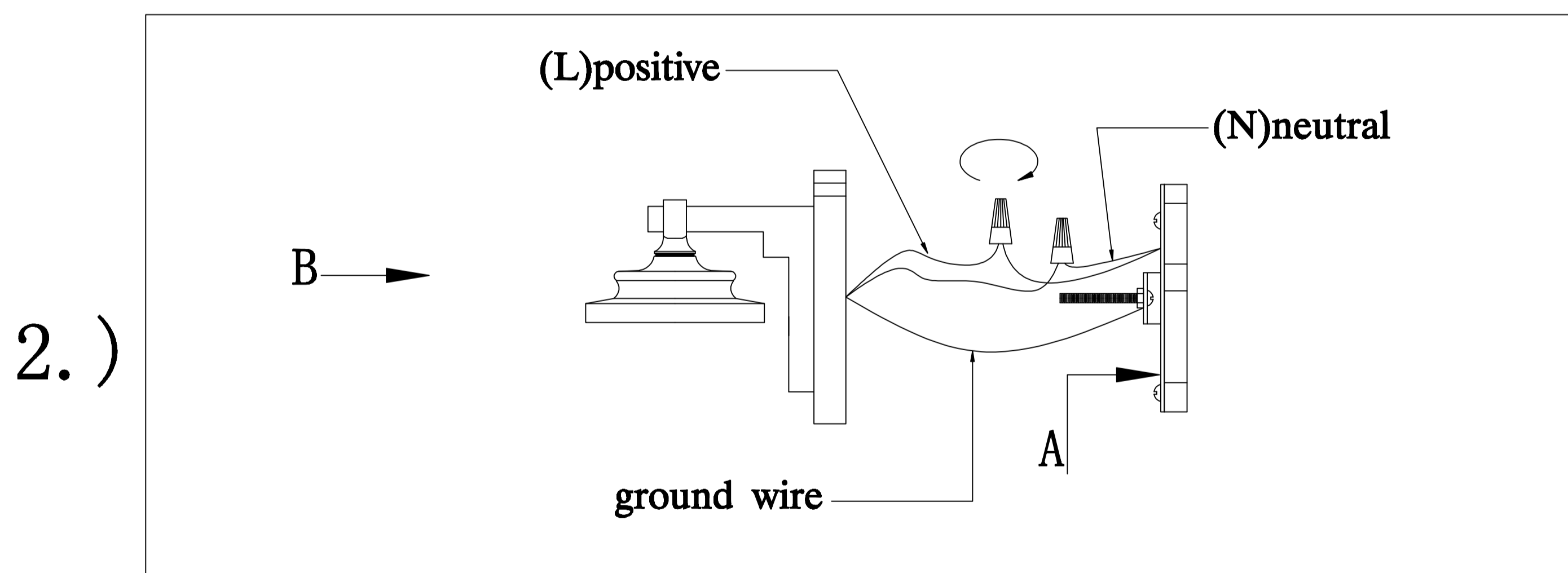

2.)

Step.2: Attach back plate to mounting bracket and tighten ball nuts so fixture meets wall. Caulk fixture where back plate meets the wall with silicone sealant.

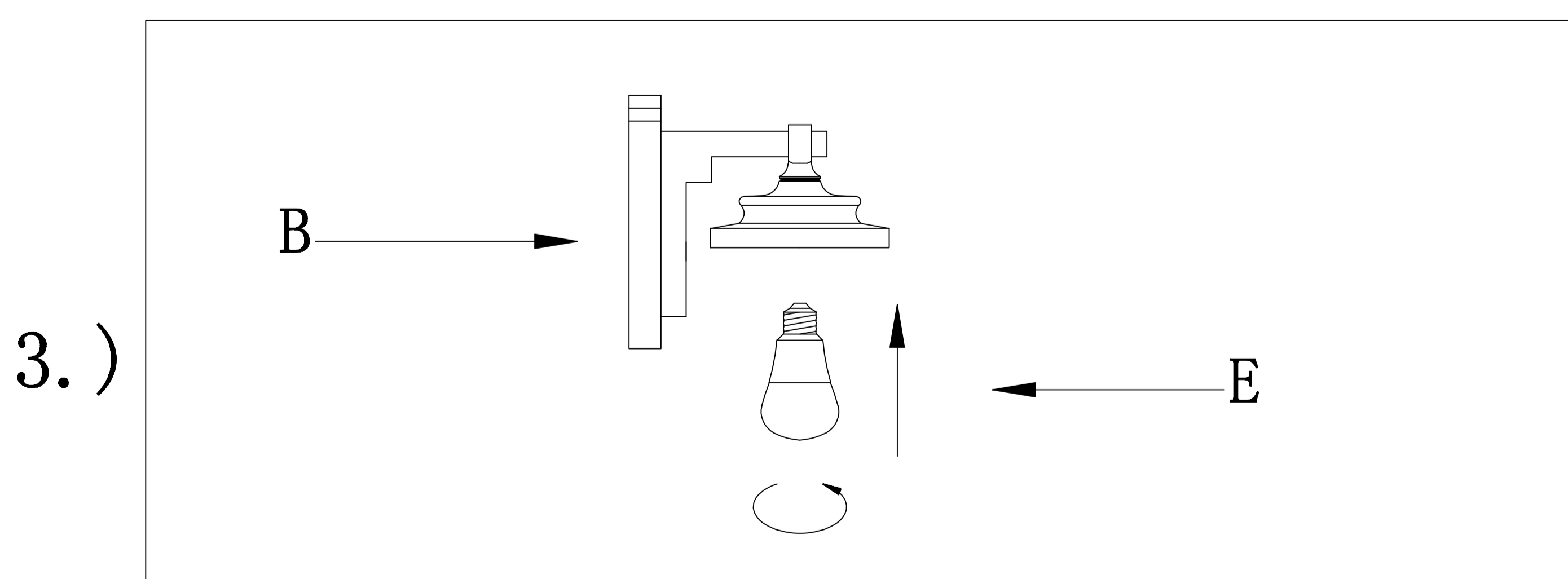

3.)

Step.3: Install E26 LED bulb(E)

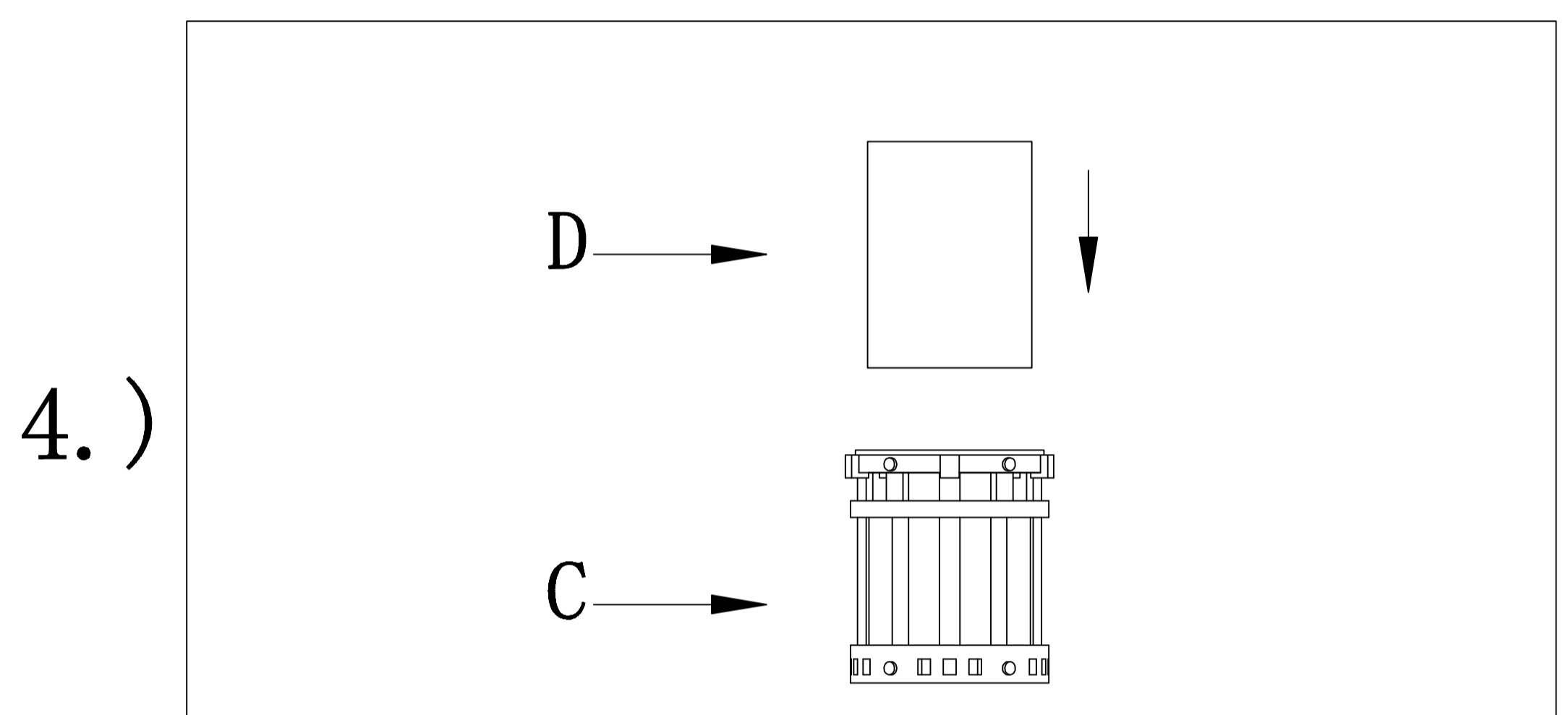

4.)

Step.4: Install the glass shade(D) into the cage(C)

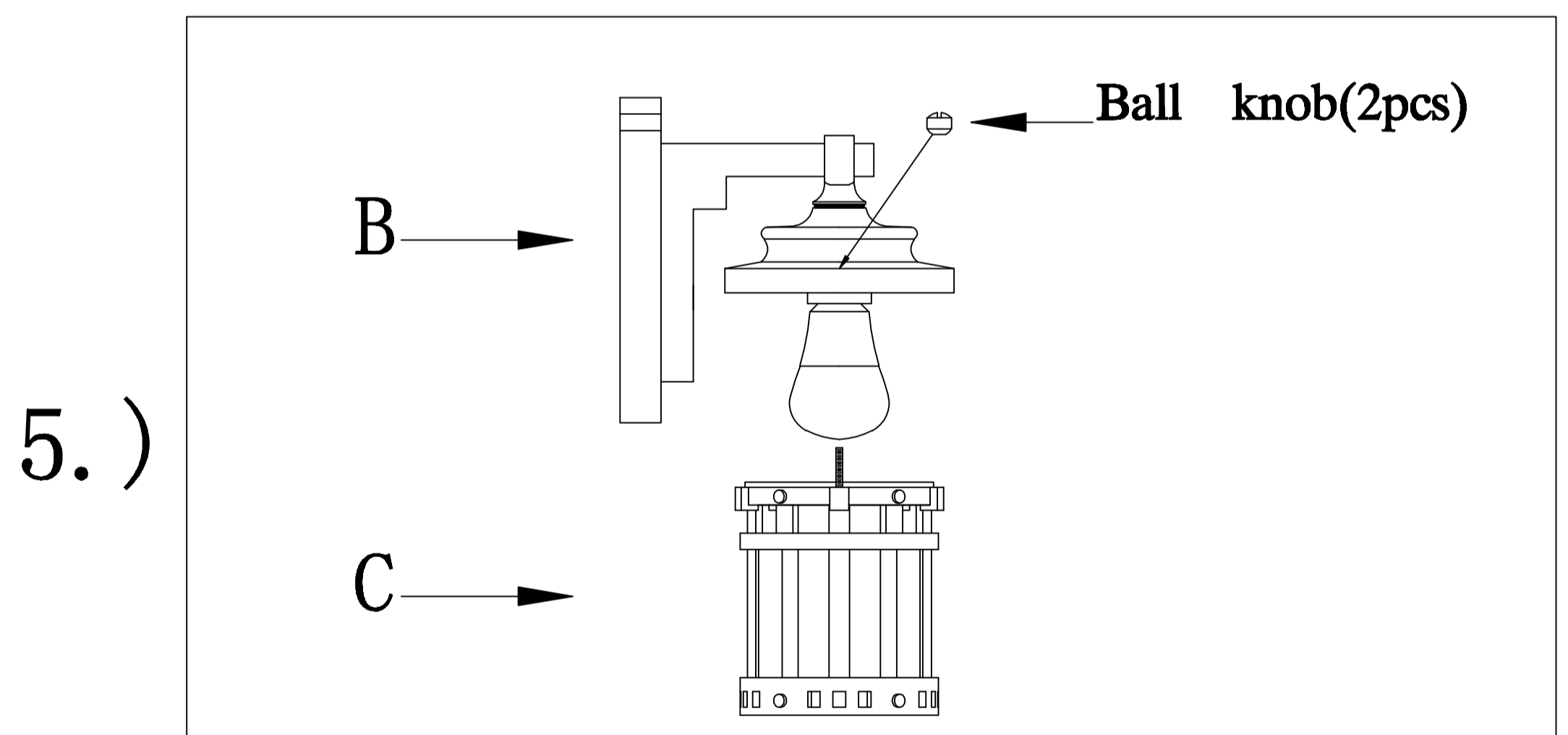

5.)

Step.5: Attach cage(C) to fixture, using ball knobs.

Cleaning & Care:
 Clean with soft cloth and a mild detergent.
 Do not use abrasive cleaner.

MADE IN CHINA