

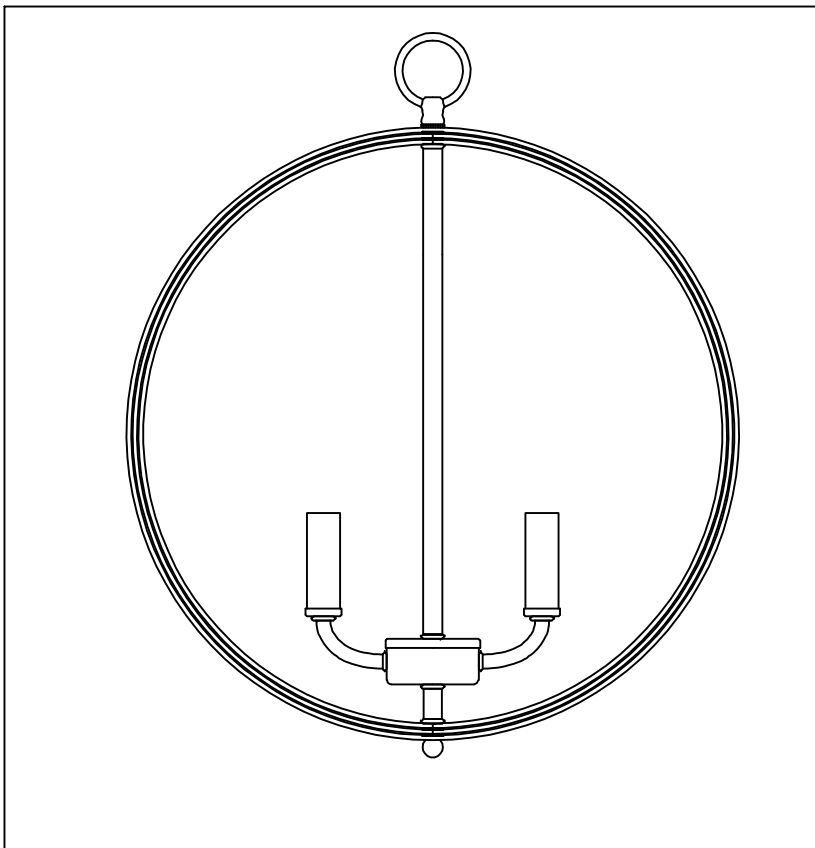

PRODUCT NAME: Provident 4-Light Chandelier
ITEM NUMBER: 10031

Please consult your electrician for hanging fixture and wiring.



Bulbs (not included):4*60w E12 Bulbs

MADE IN CHINA
 Page 1 of (2)

IMPORTANT: Turn off the power at the main fuse or circuit breaker box before starting installation



Bracket (A)



Canopy(B)



C

Locate all hardware & components before discarding packaging

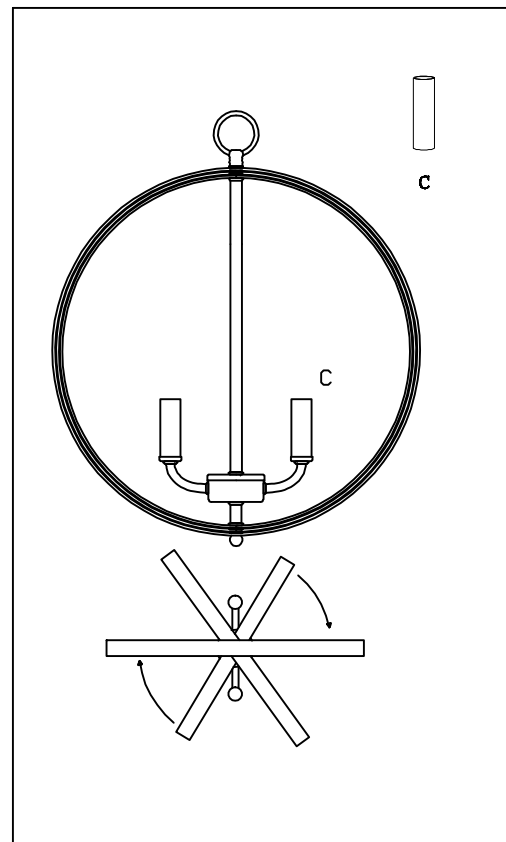

1.)

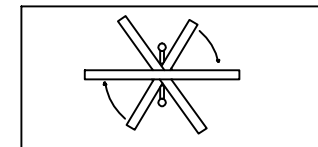

Step. 1: Rotate the rings that frame the cluster, Adjust to your desired effect.

2.)

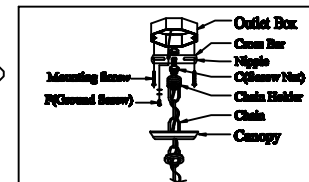

Step. 2: Attach cross bar to mounting bracket. Remove ring from loop and slide down chain. Place canopy onto chain and let slide to top of fixture. Install nipple on cross bar above chain holder

3.)

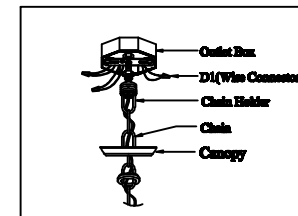

Step. 3: Wire fixture to wires in outlet box. Copper wire is for Ground. Pull canopy through screw ring up chain to ceiling and tighten securely

Cleaning & Care:
 Clean with soft cloth and a mild detergent.
 Do not use abrasive cleaner.

Page 2 of (2)