

Ø 10 mm

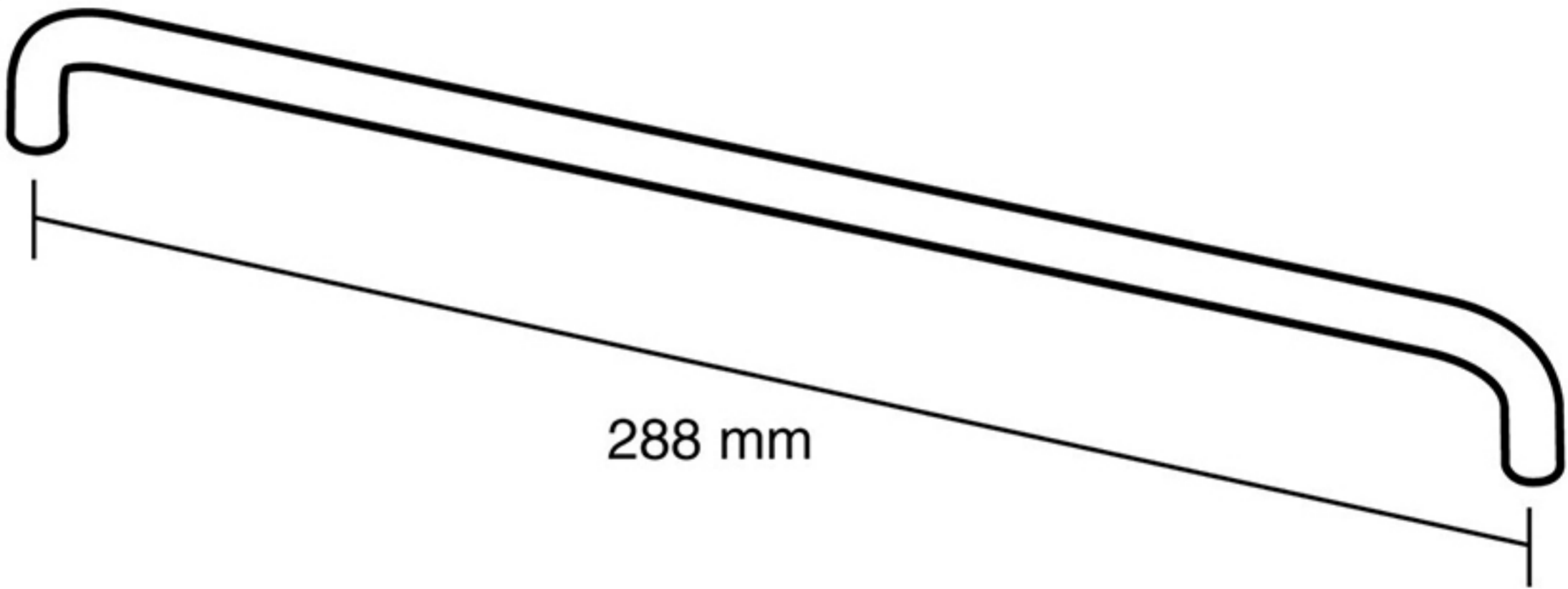

288 mm